

SOUTHLAND TOOL MFG. INC.

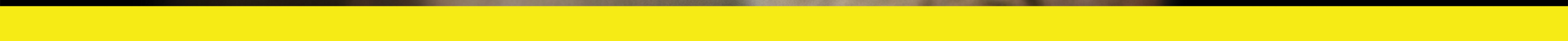

Building Innovative Tools for Municipalities



PRODUCT CATALOG 2024 v17

Southland Tool Mfg. Inc.

SEWER EQUIPMENT GUIDE

PUMA Sewer Cleaning and Inspection Equipment



| | | |
|-------------------------------------------------------------------------------------------------------------|----------------------|---------------------|
| ST-PRO CAM Jet Camera Nozzle | (T-2 PRODUCT) | Page 1 |
| Debris Baskets, Grit Catchers, Sewer Scoopas | | Page 2, 3 |
| Hose Grabbers, Choppers, Pronged Grabbers, Spoons, Shovels | | Page 4, 5 |
| Camera Hooks, Pole Mirrors | | Page 6 |
| Telescopic Claw Grabbers, Head Attachment Claw, Manhole Debris Grabber | | Page 7 |
| Handi-Clams, Sewer Magnet, Pike Pole Attachment, Hydrant Wrench, Spear Head for Poles | | Page 8 |
| Invert Shovel, Basin and Western Spoons with Handles | | Page 9 |
| Pole Carriers, Foam Filled, Aluminum, Steel Reinforced, Threaded Poles | | Page 10, 11, 12 |
| Jet & Vacuum Tools | | |
| Jetting and Vacuum Machine Accessories, Hose Guides | | Page 13 |
| Tools, Rollers, Manhole Roller Guides | | Page 14 |
| Drop Manhole Bridges, Tube Holders | | Page 15 |
| Vac-Traps | | Page 16 |
| Suction Tube Clamps, Tube Holders and Handles | | Page 17 |
| Tube Transition and Reducers, Hydro-Excavation | | Page 18, 19 |
| Industrial Vacuum Equipment | | Page 20 |
| Hydraulic Root Cutters, Motors Kits (Puma) | (T-2 PRODUCT) | Page 21 |
| Root Cutter Skids, Donut Skids, Diamond, PVC-Tap Cutter, Arrow Diamond Tipped Cutter, Septic Cleaning Tools | (T2) | Page 22 |
| More Hydraulic RCM's, Kits (Red Hot, Green Meanie, S906, S906 AK, Tiger Tooth) | | Page 23-28 |
| Sewer Rodding Tools & Accessories | | |
| Specialty Calcium, PVC Carbide Root Saw Blades, Colorado, Flat, Spiral Saw Blades | | Page 29, 30 |
| Nozzle Extensions Finned, 6 Wire Skid, 4 Wire Skid, Football Style, Proofer | | Page 31, 32 |
| Sectional Sewer Rods, Saws, Rodding Tools, Accessories | | Page 33, 34, 35, 36 |
| Porcupines, Brushes, 3 Blade Cutters | | Page 37 |
| Power Drive Rod Turning Machine, Manhole Guides Set Up, Carry All Trailer | (T-2 PRODUCT) | Page 38 |
| Loading Rack, Rods and Tool Adapters | | Page 39 |
| Continuous Rod, Adapter Couplings | (T-2 PRODUCT) | Page 40 |
| No. 5 Plumbing Rods and Tools | | Page 41 |
| "B" Rods And Tools, Coiled Spring Items, Ball Valves, 90° Swivels | (T-2 PRODUCT) | Page 42 |
| Manhole Hooks, Sand Traps, Insert Nozzle Guide, Magnet | | Page 43 |
| Anti Splash Jetting Manhole Safety Covers | | Page 44 |
| Manhole Safety Covers (Big Red New), Manhole Lifters | | Page 45 |

"ST-PRO CAM" JET CAMERA NOZZLE

Introducing the **ST-PRO CAM**. First Sewer Camera Nozzle that fits every budget. Good for 6" and up! **Self-Leveling**. Now every jetter can have one, full time! Easy to use and easy on the budget.

New Product



SUPERIOR ILLUMINATION AND SELF-LEVELING

Check out these INCLUDED Features:

- Self leveling **GoPro 11 CAMERA**. Hi-Tech Stabilized
- Stainless Steel camera enclosure case
- 6" to 8" adjustable skids and Nylon wheels (available to 18")
- Mini Sdi Card and Card reader, App readable
- Rear 1" thrust nozzle with 8 jets (plugs included for lower gpm.)
- 3 adjustable 1600 lumen LED Flashlights, 3 Rechargeable batteries included
- 3 hour run time, Wi-Fi integrated wireless downloadable to phone app



| | | |
|-----------------|---------------------------------------|-------------------|
| ST-PRO-1 | STANDARD COMPLETE KIT | \$3,531.00 |
| ST-10-12 | SKID SET FOR 10"-12" PIPE SIZE | \$ 202.00 |
| ST-15-18 | SKID SET FOR 15"-18" PIPE SIZE | \$ 241.00 |
| SN-3/4 | 3/4" REAR NOZZLE | \$ 177.00 |
| SN-1/2 | 1/2" REAR NOZZLE | \$ 161.00 |
| SRA-1 | SEWER ROD ADAPTER | \$ 161.00 |
| FPA-1 | FIBERGLASS POLE ADAPTER | \$ 274.00 |

**(No Need for Jetter. Just Push in Rods)
(Camera Case Not Included)**

SOUTHLAND TOOL MFG. INC.

Building Innovative Tools for Municipalities



PUMA TOOLS

DEBRIS BASKETS, CATCHERS, SCOOPS, GRABBERS

FLAT TRAPS FOR SKIMMING ALONG FLAT AREAS

| | | |
|--------------|--------------------------------------------------------------------------------|------------------|
| FT-6 | FLAT TRAP BASKET 6" WIDE X 6" HIGH FOR QUICK CONNECT FIBER GLASS POLES | \$ 298.00 |
| FT-8 | FLAT TRAP BASKET 8" WIDE X 6" HIGH FOR QUICK CONNECT FIBER GLASS POLES | \$ 310 00 |
| FT-10 | FLAT TRAP BASKET 10" WIDE X 8" HIGH FOR QUICK CONNECT FIBER GLASS POLES | \$ 323.00 |
| FT-12 | FLAT TRAP BASKET 12" WIDE X 8" HIGH FOR QUICK CONNECT FIBER GLASS POLES | \$ 339.00 |
| FT-15 | FLAT TRAP BASKET 15" WIDE X 8" HIGH FOR QUICK CONNECT FIBER GLASS POLES | \$ 462 00 |



DEBRIS BASKETS TO USE WITH FIBERGLASS POLE

| | | |
|--------------|-------------------------------------------------------------|------------------|
| DB-6 | DEBRIS BASKET 6" FOR QUICK CONNECT FIBERGLASS POLES | \$ 286.00 |
| DB-8 | DEBRIS BASKET 8" FOR QUICK CONNECT FIBERGLASS POLES | \$ 304.00 |
| DB-10 | DEBRIS BASKET 10" FOR QUICK CONNECT FIBERGLASS POLES | \$ 329.00 |
| DB-12 | DEBRIS BASKET 12" FOR QUICK CONNECT FIBERGLASS POLES | \$ 377.00 |
| DB-15 | DEBRIS BASKET 15" FOR QUICK CONNECT FIBERGLASS POLES | \$ 438.00 |
| DB-18 | DEBRIS BASKET 18" FOR QUICK CONNECT FIBERGLASS POLES | \$ 511.00 |



LARGER CUSTOM SIZES AVAILABLE UPON REQUEST - CALL IN FOR PRICING

DEBRIS GRIT CATCHERS TO USE WITH FIBERGLASS POLES

| | | |
|---------------|-------------------------------------------------------------------|------------------|
| DB-6S | DEBRIS GRIT CATCHER 6" FOR QUICK CONNECT FIBERGLASS POLES | \$ 329.00 |
| DB-8S | DEBRIS GRIT CATCHER 8" FOR QUICK CONNECT FIBERGLASS POLES | \$ 347.00 |
| DB-10S | DEBRIS GRIT CATCHER 10" FOR QUICK CONNECT FIBERGLASS POLES | \$ 364.00 |
| DB-12S | DEBRIS GRIT CATCHER 12" FOR QUICK CONNECT FIBERGLASS POLES | \$ 419.00 |
| DB-15S | DEBRIS GRIT CATCHER 15" FOR QUICK CONNECT FIBERGLASS POLES | \$ 473.00 |
| DB-18S | DEBRIS GRIT CATCHER 18" FOR QUICK CONNECT FIBERGLASS POLES | \$ 550.00 |



LARGER CUSTOM SIZES AVAILABLE UPON REQUEST - CALL IN FOR PRICING

*****Includes Solid Half Bottom And Back To Catch The Grit*****

DEBRIS BASKET WITH 25' ROPE

| | | |
|---------------|------------------------------------|------------------|
| DBR-6 | DEBRIS BASKET 6" WITH ROPE | \$ 269.00 |
| DBR-8 | DEBRIS BASKET 8" WITH ROPE | \$ 283.00 |
| DBR-10 | DEBRIS BASKET 10" WITH ROPE | \$ 301.00 |
| DBR-12 | DEBRIS BASKET 12" WITH ROPE | \$ 344.00 |
| DBR-15 | DEBRIS BASKET 15" WITH ROPE | \$ 395.00 |
| DBR-18 | DEBRIS BASKET 18" WITH ROPE | \$ 481.00 |



LARGER CUSTOM SIZES AVAILABLE UPON REQUEST - CALL IN FOR PRICING

**All tools come standard with Quick-Connect Male Ends.
Threaded ends or Cues end available, see below**

To use CUES POLES with the above BASKETS - ADD "C" after the part # (i.e. DB-6C) - Add \$16.00

To use Threaded Poles with the above BASKETS - ADD "T" after the part #(i.e. DB-6T) -Add \$16.00



STEEL DEBRIS GRIT CATCHER WITH 25' ROPE

| | | | |
|----------------|---------------------|----------------------|------------------|
| DBR-6S | DEBRIS GRIT CATCHER | 6" WITH ROPE | \$ 312.00 |
| DBR-8S | DEBRIS GRIT CATCHER | 8" WITH ROPE | \$ 323.00 |
| DBR-10S | DEBRIS GRIT CATCHER | 10" WITH ROPE | \$ 341.00 |
| DBR-12S | DEBRIS GRIT CATCHER | 12" WITH ROPE | \$ 383.00 |
| DBR-15S | DEBRIS GRIT CATCHER | 15" WITH ROPE | \$ 435.00 |
| DBR-18S | DEBRIS GRIT CATCHER | 18" WITH ROPE | \$ 521.00 |



LARGER CUSTOM SIZES AVAILABLE UPON REQUEST - CALL IN FOR PRICING

*****Includes Solid Half Bottom And Back To Catch The Grit*****

ALUMINUM DEBRIS TRAPS, LIGHT AND NON-CORROSIVE ALUMINUM

| | | |
|---------------|--------------------------------------------------------------------|------------------|
| ADT-6 | 6" ALUMINUM DEBRIS/SAND TRAP FOR USE WITH FIBERGLASS POLES | \$ 306.00 |
| ADT-8 | 8" ALUMINUM DEBRIS/SAND TRAP FOR USE WITH FIBERGLASS POLES | \$ 323.00 |
| ADT-10 | 10" ALUMINUM DEBRIS/SAND TRAP FOR USE WITH FIBERGLASS POLES | \$ 346.00 |
| ADT-12 | 12" ALUMINUM DEBRIS/SAND TRAP FOR USE WITH FIBERGLASS POLES | \$ 369.00 |
| ADT-15 | 15" ALUMINUM DEBRIS/SAND TRAP FOR USE WITH FIBERGLASS POLES | \$ 403.00 |
| ADT-18 | 18" ALUMINUM DEBRIS/SAND TRAP FOR USE WITH FIBERGLASS POLES | \$ 430.00 |



Also Available with 25' Rope



With Rope

SCOOPA-STRONG HEAVY DUTY MADE TO FIT IN SEWER INVERT TO CATCH DEBRIS, ZINC PLATED

| | | |
|--------------|----------------------------------------|------------------|
| SC-4 | 4" SCOOPA FOR FIBERGLASS POLES | \$ 161.00 |
| SC-6 | 6" SCOOPA FOR FIBERGLASS POLES | \$ 174.00 |
| SC-8 | 8" SCOOPA FOR FIBERGLASS POLES | \$ 180.00 |
| SC-10 | 10" SCOOPA FOR FIBERGLASS POLES | \$ 188.00 |
| SC-12 | 12" SCOOPA FOR FIBERGLASS POLES | \$ 215.00 |



SCOOPA SCREENS KEEPS DEBRIS FLOW FROM SPILLING OVER BACK OF TOOL. GOOD FOR CATCHING ROOTS. ZINC PLATED

| | | |
|----------------|-----------------------------------------------|------------------|
| SCCS-6 | 6" SCOOPA SCREEN FOR FIBERGLASS POLES | \$ 194.00 |
| SCCS-8 | 8" SCOOPA SCREEN FOR FIBERGLASS POLES | \$ 201.00 |
| SCCS-10 | 10" SCOOPA SCREEN FOR FIBERGLASS POLES | \$ 218.00 |
| SCCS-12 | 12" SCOOPA SCREEN FOR FIBERGLASS POLES | \$ 231.00 |



SCOOPA FULL FLOW SCREENS, ZINC PLATED

| | | |
|---------------|----------------------------------------------------------------|------------------|
| SCP-6 | 6" FULLY PERFORATED SCOOPA SCREEN FOR FIBERGLASS POLES | \$ 215.00 |
| SCP-8 | 8" FULLY PERFORATED SCOOPA SCREEN FOR FIBERGLASS POLES | \$ 226.00 |
| SCP-10 | 10" FULLY PERFORATED SCOOPA SCREEN FOR FIBERGLASS POLES | \$ 248.00 |
| SCP-12 | 12" FULLY PERFORATED SCOOPA SCREEN FOR FIBERGLASS POLES | \$ 271.00 |



All tools come standard with Quick-Connect Male Ends. Threaded ends or Cues end available, see below

To use CUES POLES with the above BASKETS - ADD "C" after the part # (i.e. DB-6C) - Add \$16.00

To use Threaded Poles with the above BASKETS - ADD "T" after the part # (i.e. DB-6T) -Add \$16.00



GREASE LOG CHOPPER

LC-9 6" CURVED CHOPPER FOR FIBERGLASS POLES. GREASE LOG CHOPPER NOW WITH CURVED SIDE TO BETTER PUSH MATERIAL. THESE CHOPPERS ARE VERY SHARP AND CAN CHOP UP WOOD AND GREASE OR MUD OR ANYTHING YOU WANT. ZINC PLATED

\$ 118.00



LC-9

SPOONS

PS-1 9" DIA. ROUNDED CATCH BASIN SPOON. CONNECTS TO ALL OUR POLES THIS IS A 9" DIAMETER STEEL SPOON THAT WILL SCOOP OUT LARGER AMOUNTS OF MUC AND DEBRIS. FITS ANY LENGTHS OF FIBERGLASS POLES. ALSO USED ON OUR WOOD HANDLED SEWER SPOONS, ZINC PLATED

\$ 154.00



PS-1

WSS-1 9" DIA. WESTERN STYLE SPOONS ARE GREAT WITH NICE STRONG BENT ANGLED FLAT PART AND TURNED UP EDGES THAT IS IDEAL FOR CLEANING OUT THOSE HARD TO GET AREAS. ALSO USED ON OUR WOOD HANDLE SPOONS (SEE PAGE 9) ZINC PLATED

\$ 161.00



WSS-1

SHOVELS

SIS-1 INVERT SHOVEL ATTACHMENT - ATTACHES TO ALL OUR POLE SYSTEMS, GREAT FOR DIGGING, MOVING DEBRIS IN INVERTS. NICE ROUNDED SIDE MAKES IT PERFECT TO FIT IN AN 8" INVERT. BLACK STEEL.

\$ 130.00



SIS-1

FS-IT FLAT SHOVEL ATTACHMENT - ATTACHES TO ALL OUR POLE SYSTEMS THIS FLAT SHOVEL IS GREAT FOR SCRAPING WELL SIDES AND CHIPPING UP FLOATING DEBRIS. BLACK STEEL.

\$ 131.00



FS-IT

CS-IT SPADE ROUNDED SHOVEL. FOR USE WITH FIBERGLASS POLES, GOOD ALL AROUND SHOVEL. WORKS WELL IN AREAS WHERE YOU NEED TO SLIDE AND PUNCTURE DEBRIS. BLACK STEEL.

\$ 143.00



CS-IT

SEWER MAGNET

SMAG-1 SEWER MAGNET, 100LB CAPACITY, AN OVERALL METAL RETRIEVER. GREAT TOOL FOR RETRIEVING THAT LOST TOOL, CAN LIFT VALVE. COVERS COMES WITH STEEL PROTECTIVE PLATE TO PROTECT MAGNET. ZINC PLATED.

\$ 118.00



All tools come standard with Quick-Connect Male Ends. Threaded ends or Cues end available, see below

To use CUES POLES with the above BASKETS - ADD "C" after the part # (i.e. DB-6C) - Add \$16.00

To use Threaded Poles with the above BASKETS - ADD "T" after the part # (i.e. DB-6T) -Add \$16.00



SEWER HOSE GRABBERS

HG-1 8" WIDE IMPROVED HOSE GRABBER FOR FIBERGLASS POLES, ANGLE ENDS TO ALLOW EASY ENTRY FOR HOSE. THIS TOOL IS GREAT FOR PUSHING DOWN ON THE HOSE AS THE NOZZLE COMES OUT OF LINE. KEEPS IT HORIZONTAL. ¼" THICK STEEL. ZINC PLATED. **\$ 125.00**



SHT-1 7" WIDE OPPOSITE HOSE GRABBER, OPPOSING C HOOKS GRAB HOSE IN MIDDLE AND TWIST FOR EASY GRABBING. ALLOWS YOU TO MOVE THE HOSE FROM SIDE TO SIDE OR PUSH ON IT IN ANY DIRECTION. MADE OF STRONG ¾" SPRING STEEL, ZINC PLATED. **\$ 131.00**

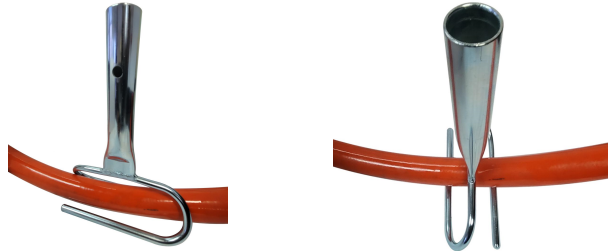

DEBRIS GRABBERS, HOOKS, CLAWS, SHOVELS, SPOONS

MAGNETS 4 PRONGED DEBRIS GRABBER

4PG-1 8" WIDE 4 PRONGED DEBRIS GRABBER - PULLS OUT ROOTS, ROCKS, CANS AND OTHER DEBRIS FROM MANHOLE. ZINC PLATED **\$ 169.00**

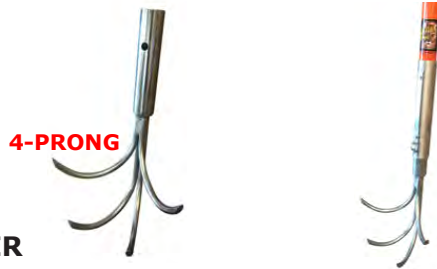

3 PRONGED DEBRIS GRABBER

3PG-1 6" WIDE 3 PRONGED DEBRIS GRABBER. SAME AS ABOVE BUT 3 PRONGS. EACH PRONG IS MADE OF STRONG SPRING STEEL. THESE ARE SHARP AND WILL PUNCTURE A CAN OR GRAB FIBROUS ROOTS. ZINC PLATED **\$ 167.00**



RAKE

BITZ-R 12" LONG BITZ RAKE. GREAT FOR GETTING MATERIAL OUT OF INVERTS AND CAN BE INSERTED INTO PIPE FOR CATCHING HANGING MATERIAL. ZINC PLATED **\$ 156.00**



SR4-1 4 PRONGED 90° RAKE. GREAT FOR GRABBING ROOTS FROM SEWER OR STORM DRAINS FITS OUR FIBERGLASS POLES AND IS MADE OF HARD SPRING STEEL WITH SHARPENED, POINTED ENDS. ZINC DIPPED FOR CORROSION RESISTANCE. **\$ 158.00**



All tools come standard with Quick-Connect Male Ends. Threaded ends or Cues end available, see below

To use CUES POLES with the above BASKETS - ADD "C" after the part # (i.e. DB-6C) - Add \$16.00

To use Threaded Poles with the above BASKETS - ADD "T" after the part # (i.e. DB-6T) - Add \$16.00



CAMERA HOOKS

New design

CAM-1 CAMERA HEX HOOK. TESTED TO 200 LBS **\$ 124.00**



CAM-2 SMALL DIAMETER CAMERA GAFFING HOOK 3"
Made of strong spring steel and cold bent to the right hook design.
Connects to our fiberglass poles. Red ball on end is removable. Zinc Plated

\$ 124.00



SSCAM-1S 2" SIDE TO SIDE CAMERA SWIVEL HOOK.
Easy to turn to get around harness or bridel this camera hook articulates so you can get the hook into any position you want by moving and turning your pole.

\$ 149.00



ECL-1 ENVIROTYPE CAMERA LIFTING HOOK WITH SIDE PICK UP BARS AND POLE ADAPTER. This will lift your envirosight camera easily. Now you can have more control when grabbing this type of rover camera. Zinc Plated

\$ 189.00



IBAK-1 IBAK SEWER CAMERA LIFT TOOL
This hook fits our standard quick connect poles. It is laser cut of 5/16" thick material with 1/2" swivel bolt to easily lift your crawler. Tested to 300 lbs. lifting capacity. includes an extra rope loop for added security for your investment.

\$ 285.00



PIKE POLE ATTACHMENT

PP-125 PIKE POLE ATTACHMENT FOR POLES. Tough like firefighters the pike pole attachment is made of cast steel. Painted Black **\$ 167.00**



AW-1 ADJUSTABLE HYDRANT WRENCH (STEEL HANDLE, CAST IRON HEAD) **\$ 38.00**



SPH-5 SPEARHEAD FOR POLES - MADE OF MACHINED STEEL AND HARDENED. THIS ATTACHEMENT TURNS YOUR FIBERGLASS POLE INTO A JABBING, PIERCING AND BREAKING TOOL **\$ 70.00**



All tools come standard with Quick-Connect Male Ends. Threaded ends or Cues end available, see below

To use CUES POLES with the above BASKETS - ADD "C" after the part # (i.e. DB-6C) - Add \$16.00

To use Threaded Poles with the above BASKETS - ADD "T" after the part # (i.e. DB-6T) -Add \$16.00



CLAW TELESCOPIC POLE GRABBERS

BEST TOOL FOR FISHING/EXTRACTING VERTICALLY

- | | | |
|----------------|----------------------------------------------------------------------------------------|------------------|
| GWCT-12 | 6' - 12' TELESCOPIC FIBERGLASS POLE LONG GRABBER WITH SPRING LOADED CLAW ACTION | \$ 352.00 |
| GWCT-16 | 8' - 16' TELESCOPIC FIBERGLASS POLE LONG GRABBER WITH SPRING LOADED CLAW ACTION | \$ 399.00 |
| GWCT-24 | 8' - 24' TELESCOPIC FIBERGLASS POLE LONG GRABBER WITH SPRING LOADED CLAW ACTION | \$ 404.00 |



GRABBER HEAD ATTACHMENT CLAW

- CRW-1** CLAW FOR ATTACHING TO POLES. INCLUDES CLAW, ROPE PVC STAY, ONE-WAY CLEAT, HARDWARE AND ALL YOU NEED TO CONNECT TO OUR FIBERGLASS POLES. EXTENDS TO 24' OR MORE DEPENDING ON THE LENGTH YOU NEED. JUST ADD MORE POLES **\$ 210.00**



MANHOLE DEBRIS GRABBER

- | | | |
|---------------|------------------------------------------------------|------------------|
| SGP-15 | 5' TO 15' LONG STEEL TELESCOPIC GRABBER PRONG | \$ 358.00 |
| SGP-24 | 8' TO 24' LONG STEEL TELESCOPIC GRABBER PRONG | \$ 424.00 |

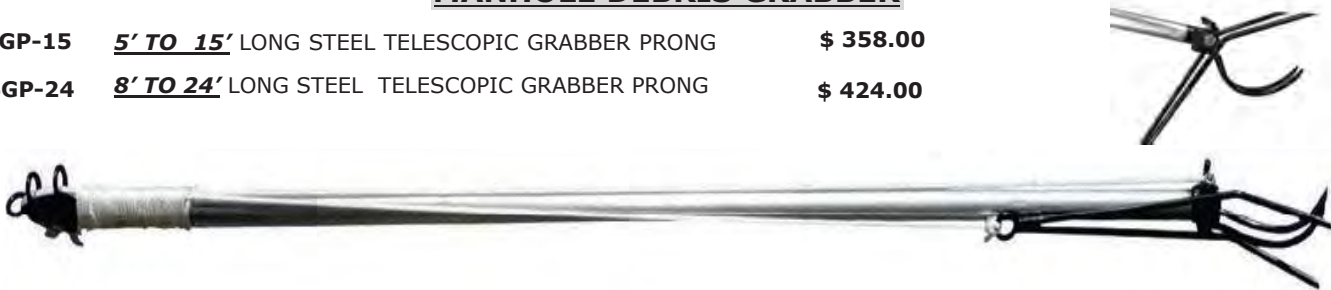

POLE INSPECTION MIRRORS

ALL COME WITH MALE QUICK CONNECT END TO FIT OUR POLES

- | | | |
|--------------|---------------------------------------------------------------------|------------------|
| IMR-1 | 4" X 6" SEWER MIRROR COMPLETE WITH PADDED COVER WITH VELCRO | \$ 142.00 |
| IMR-2 | 6" X 6" SEWER MIRROR COMPLETE WITH PADDED COVER WITH VELCRO | \$ 154.00 |
| IMR-3 | 8" X 10" SEWER MIRROR COMPLETE WITH PADDED COVER WITH VELCRO | \$ 167.00 |



HANDI-CLAMS ONE PIECE OR KNOCKDOWN MODELS - 12" -16" BUCKETS

The HANDI-CLAM is one of the most popular tools on the market for sewer/catch basin/pit cleaning. The lower end has 2 clams shell shaped buckets that are actuated by the top handle and close tight when you lock the handle. The big advantage is that we make these knockdown models so you do not have to pay high truck freight rates for a HANDI-CLAM over 8ft long. So when you buy a 12' clam it comes in two sections that are easily put together by the enclosed instructions. Plus you can use the clam as a 6 footer or 12 footer.

- | | | |
|------------------|-----------------------------------------------------------------|------------------|
| SHC-6 | 6' LONG HANDY CLAM WITH SMALL 12" BUCKET (ONE PIECE) | \$ 375.00 |
| SHC-8 | 8' LONG HANDY CLAM WITH SMALL 12" BUCKET (TWO PIECE) | \$ 398.00 |
| SHC-10 | 10' LONG HANDY CLAM WITH SMALL 12" BUCKET (TWO PIECE) | \$ 458.00 |
| SHC-12 | 12' LONG HANDY CLAM WITH SMALL 12" BUCKET (TWO PIECE) | \$ 547.00 |
| SHC-16 | 16' LONG HANDY CLAM WITH SMALL 12" BUCKET (THREE PIECES) | \$ 645.00 |
| SHC-18 | 18' LONG HANDY CLAM WITH SMALL 12" BUCKET (THREE PIECES) | \$ 703.00 |
| SHC-20 | 20' LONG HANDY CLAM WITH SMALL 12" BUCKET (FOUR PIECES) | \$ 781.00 |
| SHC-25 | 25' LONG HANDY CLAM WITH SMALL 12" BUCKET (FOUR PIECES) | \$ 923.00 |
| SHC-EX 1" | HANDY CLAM EXTENSION (Sold Per Foot) | \$ 44.00 |



ALSO AVAILABLE WITH 16" BUCKET. ADD "6" TO PART NUMBER AND THE PRICE IS THE SAME.

These can be ordered in a one piece configuration also. (EXPENSIVE TO SHIP OVER 8') and you must specify at time of order that you want a single piece clam. Extra packing and shipping charges apply for truck shipments.

INVERT SHOVEL WITH 1.5" WOOD POLE

| | | |
|----------------|----------------------------------------------------------------------------|------------------|
| SIS-6 | 6' INVERT SHOVEL WITH WOOD POLE (1 PIECE) | \$ 269.00 |
| SIS-8 | 8' INVERT SHOVEL WITH WOOD POLE (1 PIECE) | \$ 280.00 |
| SIS-102 | 10' INVERT SHOVEL WITH WOOD POLE (2 PIECE, 2ea. 5ft) | \$ 317.00 |
| SIS-122 | 12' INVERT SHOVEL WITH WOOD POLE (2 PIECE, 2ea. 6ft) | \$ 339.00 |
| SIS-162 | 16' INVERT SHOVEL WITH WOOD POLE (2 PIECE, 2ea. 8ft) | \$ 371.00 |
| SIS-183 | 18' INVERT SHOVEL WITH WOOD POLE (3 PIECE, 3ea. 6ft) | \$ 398.00 |
| SIS-203 | 20' INVERT SHOVEL WITH WOOD POLE (3 PIECE, 2ea. 7ft & 1ea. 6ft) | \$ 419.00 |



2 PIECE CONNECTION

CATCH BASIN SPOONS WITH FIBERGLASS POLES

| | | |
|--------------|-------------------------------------------------------------|------------------|
| FS-6 | 6' CATCH BASIN SPOON WITH ONE 6' FIBERGLASS POLE | \$ 241.00 |
| FS-12 | 12' CATCH BASIN SPOON WITH TWO 6' FIBERGLASS POLES | \$ 323.00 |
| FS-18 | 18' CATCH BASIN SPOON WITH THREE 6' FIBERGLASS POLES | \$ 405.00 |



CATCH BASIN SPOONS WITH 1.5" WOOD POLE

| | | |
|---------------|--------------------------------------------------------------------------------|------------------|
| PS-6 | 6' CATCH BASIN SPOON WITH WOOD POLE (1 PIECE) | \$ 269.00 |
| PS-8 | 8' CATCH BASIN SPOON WITH WOOD POLE (1 PIECE) | \$ 280.00 |
| PS-102 | 10' CATCH BASIN SPOON WITH WOOD POLE (2 PIECE, 2ea. 5ft) | \$ 317.00 |
| PS-122 | 12' CATCH BASIN SPOON WITH WOOD POLE (2 PIECE, 2ea. 6ft) | \$ 339.00 |
| PS-162 | 16' CATCH BASIN SPOON WITH WOOD POLE (2 PIECE, 2ea. 8ft) | \$ 371.00 |
| PS-183 | 18' CATCH BASIN SPOON WITH WOOD POLE (3 PIECE, 3ea. 6ft) | \$ 398.00 |
| PS-203 | 20' CATCH BASIN SPOON WITH WOOD POLE (3 PIECE, 2ea. 7ft & 1ea. 6ft) | \$ 419.00 |

**STRONG STEEL SPOONS
HD. ASH WOOD HANDLES**



OSH STYLE "WESTERN PATTERN" SPOONS WITH 1.5" WOOD HANDLE

| | | |
|-----------------|---------------------------------------------------------------|------------------|
| PS-60S | 6' WESTERN PADDLE SPOON WITH POLE (1 PIECE) | \$ 269.00 |
| PS-80S | 8' WESTERN PADDLE SPOON WITH POLE (1 PIECE) | \$ 280.00 |
| PS-1020S | 10' WESTERN PADDLE SPOON WITH POLE (2 PIECE, 2ea. 5ft) | \$ 317.00 |
| PS-1220S | 12' WESTERN PADDLE SPOON WITH POLE (2 PIECE, 2ea. 6ft) | \$ 371.00 |
| PS-1620S | 16' WESTERN PADDLE SPOON WITH POLE (2 PIECE, 2ea. 8ft) | \$ 398.00 |
| PS-1820S | 18' WESTERN PADDLE SPOON WITH POLE (2 PIECE, 2ea. 9ft) | \$ 419.00 |



REAR DOOR POLE CARRIERS

- FPB-4** **4 PIECE** FIBERGLASS POLE BRACKET. Comes with bottom pegged rest and two brackets with tight stays to keep poles steady. All Aluminum Mounts to back door
- FPB-6** **6 PIECE** FIBERGLASS POLE BRACKET. Comes with bottom pegged rest and two brackets with tight stays to keep poles steady. All Aluminum Mounts to back door



SINGLE POLE CARRIERS

- SDS-1** HIGH QUALITY CAST DESIGN FOR CARRYING A SINGLE POLE. One side is a closed circle. **\$ 145.00**
- SDS-2** DOUBLE CARRIER WITH RUBBER GASKET TO PROTECT THE POLE. The other side is an open half-moon with a pull-tight and locking rubber strap to keep poles in place. **\$ 210.00**



FIBERGLASS POLE SETS

FIBERGLASS POLES STANDARD WEIGHT ORANGE QUICK CONNECT

- | | | |
|----------------|--------------------------------------------------------------------------------------------------------|------------------|
| STD-3 | 3' SINGLE MALE X FEMALE POLE | \$ 66.00 |
| STD-6 | 6' SINGLE MALE X FEMALE POLE | \$ 77.00 |
| STD-18 | 18' SET OF 2ea. 6' QUICK CONNECT MALE X FEMALE POLE & 1ea. 6' FEMALE X RUBBER END | \$ 220.00 |
| STD-21 | 21' SET OF 3ea. 6' QUICK CONNECT MALE X FEMALE POLE & 1ea. 3' MALE X FEMALE POLE | \$ 282.00 |
| STD-24 | 24' SET OF 3ea. 6' QUICK CONNECT MALE X FEMALE POLE & 1ea. 6' FEMALE X RUBBER END | \$ 295.00 |
| STD-6R | SINGLE 6' QUICK CONNECT POLE WITH FEMALE END X RUBBER END POLE | \$ 77.00 |
| STD-12R | SINGLE 12' QUICK CONNECT POLE WITH FEMALE END X RUBBER END POLE | \$ 184.00 |



TELESCOPIC FIBERGLASS POLES

- | | | |
|--------------|-------------------------------------------|------------------|
| EXT-3 | 6' - 12' FIBERGLASS EXTENSION POLE | \$ 195.00 |
| EXT-1 | 8' - 16' FIBERGLASS EXTENSION POLE | \$ 218.00 |
| EXT-2 | 8' - 24' FIBERGLASS EXTENSION POLE | \$ 296.00 |



STEEL REINFORCED FIBERGLASS POLES (SUPER STIFF) QUICK CONNECT

STEEL REINFORCED

- | | | |
|-----------------|------------------------------------------------------------------------------------------|------------------|
| STD-3ST | 3' SINGLE MALE X FEMALE POLE | \$ 73.00 |
| STD-6ST | 6' SINGLE MALE X FEMALE POLE | \$ 129.00 |
| STD-21ST | 21' SET OF 3ea. 6' & 1ea. 3' MALE X FEMALE POLE | \$ 437.00 |
| STD-24ST | 24' SET OF 3ea. MALE X FEMALE POLES & 1ea. FEMALE X RUBBER END POLE | \$ 490.00 |

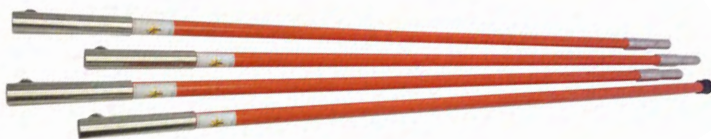

FOAM FILLED POLES FOR EXTRA STRENGTH AND SAFETY WITH QUICK CONNECT ENDS

| | | |
|--------------|--------------------------------------------------------------------------------|------------------|
| FF-3 | SINGLE 3' MALE X FEMALE POLE | \$ 81.00 |
| FF-6 | SINGLE 6' MALE X FEMALE POLE | \$ 135.00 |
| FF-8 | SINGLE 8' MALE X FEMALE POLE | \$ 218.00 |
| FF-21 | SET OF 3ea. 6' MALE X FEMALE & 1ea. 3' MALE X FEMALE POLE | \$ 462.00 |
| FF-24 | SET OF 3ea. 6' MALE X FEMALE POLES & 1ea. 6' FEMALE X RUBBER END | \$ 513.00 |
| FF-6R | POLE SINGLE 6' FEMALE X RUBBER END POLE | \$ 135.00 |

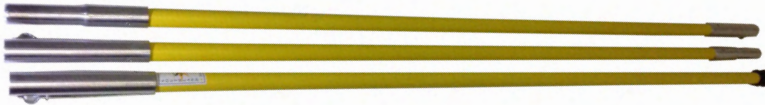

STEEL THREADED ENDS – FIBERGLASS POLES STANDARD WEIGHT ORANGE

PLEASE MAKE SURE YOUR TOOLS ARE THREADED ALSO!!

| | | |
|-----------------|-----------------------------------------------------------------------------------|------------------|
| STD-3T | SINGLE 3' MALE X FEMALE POLE | \$ 102.00 |
| STD-6T | SINGLE 6' MALE X FEMALE POLE | \$ 114.00 |
| STD-18T | SET OF 2ea. 6' MALE X FEMALE POLES & 1ea. 6' MALE X RUBBER END POLE | \$ 325.00 |
| STD-21T | SET OF 3ea. 6' MALE X FEMALE POLES & 1ea. 3' MALE X FEMALE POLE | \$ 422.00 |
| STD-24T | SET OF 3ea. 6' MALE X FEMALE POLES & 1ea. 6' MALE X RUBBER END POLE | \$ 433.00 |
| STD-6RT | SINGLE 6' MALE X RUBBER END POLE | \$ 114.00 |
| STD-12RT | SINGLE 12' MALE X RUBBER END POLE | \$ 216.00 |



STEEL THREADED ENDS – STEEL REINFORCED FIBERGLASS POLES (OUR STRONGEST POLE AVAILABLE)

PLEASE MAKE SURE YOUR TOOLS ARE THREADED ALSO!!

| | | |
|------------------|-----------------------------------------------------------------------------------|------------------|
| STD-3STT | SINGLE 3' MALE X FEMALE POLE | \$ 109.00 |
| STD-6STT | SINGLE 6' MALE X FEMALE POLE | \$ 161.00 |
| STD-18STT | SET OF 2ea. 6' MALE X FEMALE POLES & 1ea. 6' MALE X RUBBER END POLE | \$ 459.00 |
| STD-21STT | SET OF 3ea. 6' MALE X FEMALE POLES & 1ea. 3' MALE X FEMALE POLE | \$ 562.00 |
| STD-24STT | SET OF 3ea. 6' MALE X FEMALE POLES & 1ea. 6' MALE X RUBBER END POLE | \$ 612.00 |

STEEL REINFORCED



THREADED POLES CONT...

FOAM FILLED POLES FOR EXTRA STRENGTH-STEEL THREADED ENDS

PLEASE MAKE SURE YOUR TOOLS ARE THREADED ALSO

| | | | |
|---------------|--------------------------------------------------------------------------------|------------------|--|
| FF-3T | SINGLE 3' MALE X FEMALE POLE | \$ 118.00 | |
| FF-6T | SINGLE 6' MALE X FEMALE POLE | \$ 172.00 | |
| FF-21T | SET OF 3ea. 6' & 1ea. 3' MALE X FEMALE POLE | \$ 210.00 | |
| FF-24T | SET OF 2ea. 8' MALE X FEMALE POLES & 1ea. MALE X RUBBER END POLE | \$ 572.00 | |
| FF-6RT | SINGLE 6' MALE X RUBBER END POLE | \$ 160.00 | |



ALUMINUM POLE WITH ALUMINUM QUICK CONNECT ENDS (SUPER STRONG AND LIGHTWEIGHT)

| | | |
|--------------|----------------------------------------------------|------------------|
| AP-6 | SINGLE 6' MALE X FEMALE ALUMINUM POLE | \$ 157.00 |
| AP-12 | SET OF 2ea. 6' MALE X FEMALE ALUMINUM POLES | \$ 283.00 |
| AP-18 | SET OF 3ea. 6' MALE X FEMALE ALUMINUM POLES | \$ 424.00 |
| AP-24 | SET OF 4ea. 6' MALE X FEMALE ALUMINUM POLES | \$ 565.00 |



CUES[®] TYPE FIBERGLASS POLE

| | | |
|--------------|-------------------------------------------------------------------------------|-----------------|
| CTP-5 | (CUES [®] TYPE) 5' STANDARD FIBERGLASS POLE WITH ALUMINUM FEMALE END | \$ 78.00 |
|--------------|-------------------------------------------------------------------------------|-----------------|



| | | |
|----------------|-----------------------------------------------------------------------|------------------|
| CTP-5FF | (CUES [®] TYPE) 5' FOAM FILLED POLE WITH ALUMINUM FEMALE END | \$ 116.00 |
|----------------|-----------------------------------------------------------------------|------------------|



| | | |
|---------------|-------------------------------------------------------------------------------|------------------|
| CTP-5S | (CUES [®] TYPE) 5' STANDARD FIBERGLASS POLE WITH HD STEEL FEMALE END | \$ 145.00 |
|---------------|-------------------------------------------------------------------------------|------------------|



| | | |
|-----------------|-----------------------------------------------------------------------|------------------|
| CTP-5FFS | (CUES [®] TYPE) 5' FOAM FILLED POLE WITH HD STEEL FEMALE END | \$ 187.00 |
|-----------------|-----------------------------------------------------------------------|------------------|



JETTING AND VACUUM TOOLS AND ACCESSORIES

SEWER HOSE PROTECTION EQUIPMENT

SAMR-1 UPPER MANHOLE ROLLER GUIDE (36" **ALUMINUM**) WITH NYLON ROLLER **\$ 258.00**
FOR 24" MANHOLE

SAMR-48 SAME AS ABOVE WITH 48" LEGS **\$ 263.00**
FOR 36" MANHOLE

SASR-1 UPPER MANHOLE ROLLER GUIDE (**STEEL CONSTRUCTION** WITH NYLON ROLLER) **\$ 242.00**

DPTR-1 UPPER MANHOLE "Y" ROLLER WITH ROOM FOR 8" SUCTION TUBE **\$ 269.00**
 OPENS UP IN MIDDLE FOR EXTRA ROOM. HINGED SO YOU CAN USE AS CLOSED STANDARD OR OPEN "Y"

SAMA-1 UPPER MANHOLE ROLLER GUIDE (ALUMINUM) ALUMINUM ROLLER **\$ 333.00**

SJS-1 TIGER TAIL 3" X 36" **\$ 81.00**

SJS-2 TIGER TAIL 2" X 36" **\$ 81.00**

SJS-HD HEAVY DUTY TIGERTAIL PUMA HOSE GUIDE 3" Smooth bore rubber hose, steel banded cuffs, king clamp rope **\$ 274.00**
lasts 10X longer than standard Tiger Tails

SJ2-HD HEAVY DUTY PUMA HOSE GUIDE 2" **\$ 262.00**

ADJ-1 ADJUSTABLE TOP MANHOLE ROLLER. **\$ 403.00**
 Tubular Steel sides to Manholes from **24" to 36"**. Opposing brackets grab manhole ring. 3" Gap when opened up allows you to insert hose without taking apart



23 lbs. SSC-24 ANTI-SPLASH MANHOLE ROLLER GUIDE FOR **24"** MANHOLE **\$ 602.00**

51 lbs. SSC-36 ANTI-SPLASH MANHOLE ROLLER GUIDE FOR **36"** MANHOLE **\$ 672.00**

All aluminum construction with nylon roller and thick 3/8" Polycarbonate eliminates possibility of getting splashed by sewer water or falling in the manhole opening.

CORRUGATED PIPE ROLLER

STR-1 ROLLER FOR CORRUGATED PIPE PROTECTS YOUR HOSE WHEN CLEANING WHEN YOU NEED TO DROP YOUR HOSE OVER AN ELEVATED ROAD TO CLEAN A CULVERT THIS WILL PROTECT YOUR HOSE FROM SCRAPES AND SHREDDING

\$ 414.00

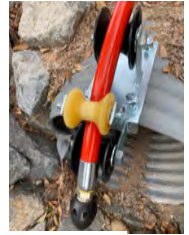

LOWER MANHOLE ROLLER GUIDES

GTT-7 TIGER TAIL 5 ROLLER GUIDE WIT 25' ROPE ALL ALUMINUM LOWERS YOUR HOSE AND NOZZLES INTO SEWER PIPE. PROTECTS HOSE, LIGHTWEIGHT AND EASY TO USE. 5 POLYPROPYLENE ROLLERS

\$ 462.00



GTT-7

LCR-5 LOWER CAMERA ROLLER. ALL ALUMINUM WITH 4 OFFSET ROLLERS, 2 REMOVABLE TO FEED CABLE THROUGH. MOVABLE SHOE FOR STANDARD FIBERGLASS POLES OR CUES STYLE PUSH BUTTON POLES

\$ 650.00



LCR-5

SDA-2 ARTICULATING ROLLER GUIDE ABLE TO GUIDE HOSE OVER AND UNDER EXPOSED ABLE PIPE OR "K" RAILS. BENDS IN THE MIDDLE SO THAT YOUR HOSE WON'T GET RIPPED UP BY CORRUGATED STEEL PIPE. 9 ROLLERS AND 2 HOSE STAYS ASSURE YOUR HOSE STAYS IN POSITION. COMES WITH 25' NYLON ROPE

\$ 891.00



SDA-2

729-A COMPACT LOWER MANHOLE ROLLER, STEEL, WITH 4 YELOW POLYURETHANE ROLLERS. SAFETY ORANGE WITH TOP ADAPTER FOR FIBERGLASS POLE (3/16" THICK STEEL 13"L X 15"H)

\$ 414.00

729-A



SHDS-1 ALUMINUM LOWER MANHOLE ROLLER GUIDE SHOE - FOR LARGER LINES (4 NYLON ROLLERS) 3/4" THREADED CONNECTION. POLES NOT INCLUDED (21 1/2 X 21 1/2)

\$ 485.00

SHDS-1



SHDS-1ST SAME AS ABOVE BUT STEEL CONSTRUCTION \$ 434.00

LMER-1 LOWER MANHOLE EASEMENT ROLLER. ALLOWES OPERATOR TO CHANGE DIRECTION OF HOSE IN MANHOLE THAT HAS DENIED ACCESS. THIS TOOL/ROLLER ALLOWS YOU TO TURN THE HOSE 90° DERLIN ROLLER SPINS ON 2 SEALED BEARINGS

\$ 231.00

LMER-1



SSR-5 STAKE ROLLER FOR HOSE TO GO AROUND BENDS HARDENED POINT AND HEAD. SPADE TO KEEP FROM TURNING

\$ 421.00

SSR-5



HGR-1 HOSE GUIDE ROLLER-GRABBER FOR FIBERGLASS POLES

\$ 333.00



HGR-1

HGR-1T HOSE GUIDE ROLLER-GRABBER FOR THREADED POLES HOSE IS CRADLED IN LOWER HOOKS TO ALLOW YOU TO LAUNCH THE REPLACEMENT NOZZLE WITH ROLLER ALREADY IN PLACE

\$ 344.00

PR-1 DELRIN REPLACEMENT ROLLER BLACK **4 1/4" Wide** \$ 48.00



PR-1Y YELLOW POLYURETHANE REPLACEMENT ROLLER \$ 48.00



PR-1-WB DELRIN REPLACEMENT ROLLER WITH 2 INTEGRATED SEALED BEARINGS \$ 65.00



FE-1 POLE ADAPTER. CONNECTS TO 3/4" THREADED NPT FOR ABOVE GUIDE SHOE ROLLERS TO OUR QUICK CONNECT FIBERGLASS POLES \$ 41.00

FE-1



DROP MANHOLE BRIDGE (3 DIFFERENT WIDTHS!!)

DMB-1 DROP MANHOLE BRIDGE FOR **8" SEWER LINE and UP 48" LONG BRIDGE** \$ 230.00
(This is our most commonly used size. Made for a crawler with a 6" width)
(Includes Pole Connector & 25' Rope for leveling)

DMB-1S DROP MANHOLE BRIDGE FOR **6" SEWER LINE. 48" LONG BRIDGE** \$ 230.00
(This is our smallest bridge 4" width)
(Includes Pole Connector & 25' Rope for leveling)

DMB-2 DROP MANHOLE BRIDGE FOR **8" SEWER LINE. 60" LONG BRIDGE** \$ 237.00
(Includes Pole Connector & 25' Rope for leveling/6.25" width)

DMB-3 DROP MANHOLE BRIDGE FOR **10" SEWER LINE. 48" LONG BRIDGE** \$ 272.00
(Includes Pole Connector & 25' Rope for leveling/7.25" width)

DMB-4 DROP MANHOLE BRIDGE FOR **12" SEWER LINE. 48" LONG BRIDGE** \$ 296.00
(Includes Pole Connector & 25' Rope for leveling/8.75" width)

DMB-1-24 DROP MANHOLE BRIDGE KIT. \$ 511.00
(Includes: Set of 24' Long Poles STD-24)
CHOOSE EITHER 6" OR 8" PIPE SIZE

- Part#: DMB-1-24-6 FOR 6"
- Part#: DMB-1-24-8 FOR 8"

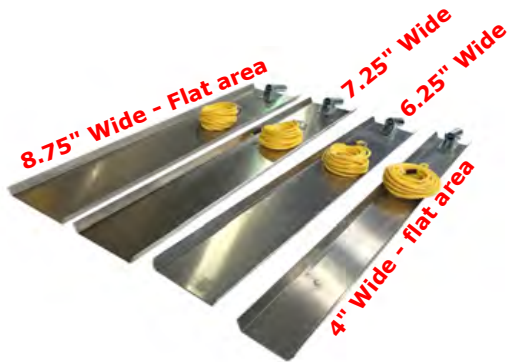
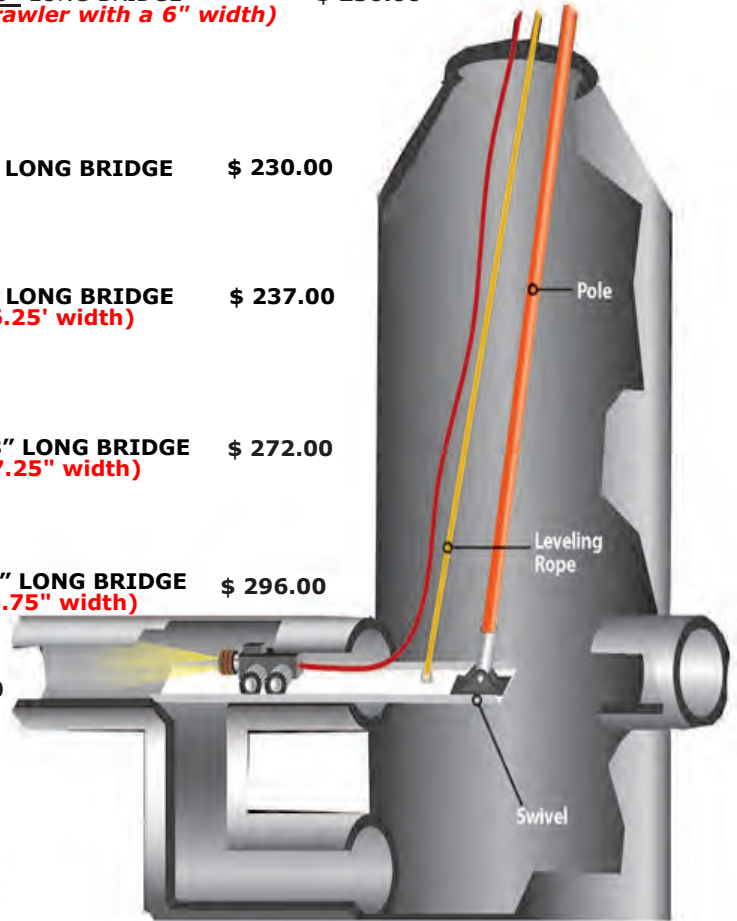

DEEP MANHOLE TUBE HOLDER

- DTH-6** 6" DEEP TUBE HOLDER. USE TO LOWER TUBES INTO MANHOLE FOR 36" \$ 255.00
DTH-8 8" DEEP TUBE HOLDER. USE TO LOWER TUBES INTO MANHOLE FOR 36" \$ 267.00
DTH-50 8" DEEP TUBE HOLDER. EXTENDED ARM TO 50" LENGTH \$ 323.00
DTH-60 8" DEEP TUBE HOLDER. EXTENDED ARM TO 60" LENGTH \$ 323.00



ALUMINUM ARMS ARE VERY LIGHT!!

BEST IDEA EVER FOR YOUR SUCTION MACHINE - VAC TRAPS!

Vac-Traps are a Patent Pending item invented by David Pryor the owner of Southland Tool Mfg. So please do not accept any imitations, but only the best, from the source.

Southland Tool Inc. makes a variety of Vac-Trap Debris Catchers. The idea behind the Vac-Trap is to keep the water in the sewer line where it belongs and remove only debris.

When you are vacuuming the debris coming down the sewer you usually are using a crown nozzle elevated above the flow on the down stream side of the invert.

This accepted way of suctioning debris means you remove a great deal of water from the sewer line that requires you to either, decant or dump the water, along with the debris. Decanting takes time, if you have the set up, and dumping water along with debris is expensive and inefficient.

The Vac-Trap allows you to keep the water in the sewer where it belongs. Just clamp on the correctly sized Vac-Trap to the end of your suction tube and lower into the invert. The sewer debris flows through it and traps the debris but lets the water filter out. You don't even have to run your PD or fan, just let the trap do the work on its own.

Once the trap is full and you see the water start to back up then simply turn on your pump and instantly vacuum the trap clean, then you're ready to start again. The Vac-trap pays for itself in just a few uses. Think of the savings of not having to run your suction pump continuously, not having to waste time to de-cant or dump later on.

Now you can fill your tank with 80% debris and only 20% water.

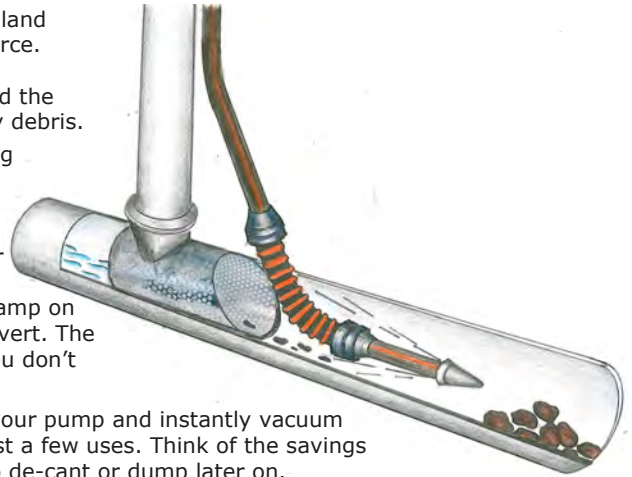

VECTOR FLAT FLANGE TYPE

| | | | |
|--------------|------------|--------------------------------------------------------|------------------|
| BT-6 | 6" | VAC-TRAP FOR 8" VACTOR SUCTION TUBE FLAT FLANGE | \$ 358.00 |
| BT-8 | 8" | VAC-TRAP FOR 8" VACTOR SUCTION TUBE FLAT FLANGE | \$ 380.00 |
| BT-10 | 10" | VAC-TRAP FOR 8" VACTOR SUCTION TUBE FLAT FLANGE | \$ 391.00 |
| BT-12 | 12" | VAC-TRAP FOR 8" VACTOR SUCTION TUBE FLAT FLANGE | \$ 418.00 |
| BT-15 | 15" | VAC-TRAP FOR 8" VACTOR SUCTION TUBE FLAT FLANGE | \$ 461.00 |
| BT-18 | 18" | VAC-TRAP FOR 8" VACTOR SUCTION TUBE FLAT FLANGE | \$ 523.00 |

FULL FLOW



VACTOR FLAT FLANGE TYPE (With Grit Covers)

| | | | |
|---------------|------------|-------------------------------------------------------------|------------------|
| BT-6S | 6" | VAC-TRAP GRIT FOR 8" VACTOR SUCTION TUBE FLAT FLANGE | \$ 413.00 |
| BT-8S | 8" | VAC-TRAP GRIT FOR 8" VACTOR SUCTION TUBE FLAT FLANGE | \$ 432.00 |
| BT-10S | 10" | VAC-TRAP GRIT FOR 8" VACTOR SUCTION TUBE FLAT FLANGE | \$ 451.00 |
| BT-12S | 12" | VAC-TRAP GRIT FOR 8" VACTOR SUCTION TUBE FLAT FLANGE | \$ 538.00 |
| BT-15S | 15" | VAC-TRAP GRIT FOR 8" VACTOR SUCTION TUBE FLAT FLANGE | \$ 554.00 |
| BT-18S | 18" | VAC-TRAP GRIT FOR 8" VACTOR SUCTION TUBE FLAT FLANGE | \$ 666.00 |

HALF MOON-CATCHES SAND

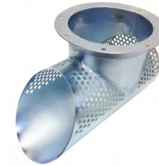

CAMEL STYLE FEMALE END (Female Bandlock)

| | | | |
|--------------|------------|----------------------------------------------|------------------|
| CT-6 | 6" | VAC-TRAP FOR 8" CAMEL TYPE FEMALE END | \$ 399.00 |
| CT-8 | 8" | VAC-TRAP FOR 8" CAMEL TYPE FEMALE END | \$ 418.00 |
| CT-10 | 10" | VAC-TRAP FOR 8" CAMEL TYPE FEMALE END | \$ 432.00 |
| CT-12 | 12" | VAC-TRAP FOR 8" CAMEL TYPE FEMALE END | \$ 526.00 |
| CT-15 | 15" | VAC-TRAP FOR 8" CAMEL TYPE FEMALE END | \$ 563.00 |
| CT-18 | 18" | VAC-TRAP FOR 8" CAMEL TYPE FEMALE END | \$ 682.00 |

FULL FLOW



CAMEL STYLE FEMALE END (Female Bandlock) (With Grit Covers)

| | | | |
|---------------|------------|---------------------------------------------------|------------------|
| CT-6S | 6" | VAC-TRAP GRIT FOR 8" CAMEL TYPE FEMALE END | \$ 464.00 |
| CT-8S | 8" | VAC-TRAP GRIT FOR 8" CAMEL TYPE FEMALE END | \$ 484.00 |
| CT-10S | 10" | VAC-TRAP GRIT FOR 8" CAMEL TYPE FEMALE END | \$ 501.00 |
| CT-12S | 12" | VAC-TRAP GRIT FOR 8" CAMEL TYPE FEMALE END | \$ 593.00 |
| CT-15S | 15" | VAC-TRAP GRIT FOR 8" CAMEL TYPE FEMALE END | \$ 630.00 |
| CT-18S | 18" | VAC-TRAP GRIT FOR 8" CAMEL TYPE FEMALE END | \$ 684.00 |



HALF MOON-CATCHES SAND

VAC-ALL MALE COUPLING END (Male bandlock)

| | | | |
|--------------|------------|-----------------------------------------|------------------|
| JT-6 | 6" | VAC-TRAP FOR 8" VAC-ALL MALE END | \$ 360.00 |
| JT-8 | 8" | VAC-TRAP FOR 8" VAC-ALL MALE END | \$ 380.00 |
| JT-10 | 10" | VAC-TRAP FOR 8" VAC-ALL MALE END | \$ 392.00 |
| JT-12 | 12" | VAC-TRAP FOR 8" VAC-ALL MALE END | \$ 484.00 |
| JT-15 | 15" | VAC-TRAP FOR 8" VAC-ALL MALE END | \$ 508.00 |
| JT-18 | 18" | VAC-TRAP FOR 8" VAC-ALL MALE END | \$ 559.00 |

FULL FLOW



VAC-ALL MALE COUPLING END (Male bandlock) (With Grit Covers)

| | | | |
|---------------|------------|----------------------------------------------|------------------|
| JT-6S | 6" | VAC-TRAP GRIT FOR 8" VAC-ALL MALE END | \$ 406.00 |
| JT-8S | 8" | VAC-TRAP GRIT FOR 8" VAC-ALL MALE END | \$ 424.00 |
| JT-10S | 10" | VAC-TRAP GRIT FOR 8" VAC-ALL MALE END | \$ 448.00 |
| JT-12S | 12" | VAC-TRAP GRIT FOR 8" VAC-ALL MALE END | \$ 472.00 |
| JT-15S | 15" | VAC-TRAP GRIT FOR 8" VAC-ALL MALE END | \$ 490.00 |
| JT-18S | 18" | VAC-TRAP GRIT FOR 8" VAC-ALL MALE END | \$ 584.00 |

HALF MOON-CATCHES SAND



ADD "6" TO END OF PART #3 FOR 6" UP-TUBE FOR ANY VAC-TRAP. SAME PRICE

SUCTION TUBE CLAMPS

(8" VACTOR STYLE QUICK CLAMP)

This Clamp does not come in a 6"

(8" VAC-CON STYLE QUICK CLAMP)

(8" VAC-CON STYLE QUICK CLAMP)



S16584
\$ 52.00

(6" VAC-CON STYLE QUICK CLAMP)



S690-0073
\$ 46.00



S680-0015
\$ 61.00

With safety pin locking device which prevents latch from opening



S680-0015WLC
\$ 83.00

6" BANDLOCK STYLE TUBE CLAMP



S42587
\$ 44.00

8" BANDLOCK STYLE TUBE CLAMP



S42588
\$ 50.00

8" BANDLOCK STYLE TUBE CLAMP

With safety pin locking device which prevents latch from opening



S42588WLC
\$ 83.00

8" VACTOR/VAC-CON STYLE TUBE HOSE CLAMP



THV-8
\$ 132.00

8" VACTOR/VAC-CON CLAMP



V-8
\$108.00

8" CAMEL/VAC-ALL STYLE TUBE HOSE CLAMP



THC-8
\$ 132.00



HYDRO-VAC TUBE HOLDER AND HANDLES

TWO HAND STYLE

- HYH-6** 6" HYDRO-VAC TUBE HOLDER WITH 2 HANDLES FOR 4" TUBE \$ 220.00
- HYH-8** 8" HYDRO-VAC TUBE HOLDER WITH 2 HANDLES FOR 8" TUBE \$ 242.00



HYH- (6) (8)

ONE HAND VACTOR STYLE

- HYH-6-VS** 6" VACTOR STYLE WITH LARGER HANDLES FOR 6" TUBE \$ 289.00
- HYH-8-VS** 8" VACTOR STYLE WITH LARGER HANDLES FOR 8" TUBE \$ 314.00

HYH-(6) (8)-VS



ONE HAND VACTOR STYLE

- HYH-8-WH** 8" TUBE CLAMP VACTOR STYLE WITH ADJUSTABLE HOOK TYPE CLAMP \$ 314.00



HYH-8-WH



"DIG IT" HYDRO-EXCAVATING TOOLS

HYDRO-EXCAVATOR TOOL "DIG-IT" Is a lightweight attachment for your sewer hose, with sewer hose size (3/4" or 1") and suction tubes sizes (6' OR 8'). The wet ring has either 4, 8 or 10 replaceable stainless steel jets according to your GPM and PSI. Jets are slightly angled and zero degrees. Bottom rubber cuff provides protection.

SMALL, COMPACT, EASY TO STORE

| PART NO. | MACHINE | TUBE SIZE | HOSE | JETS | PRICE |
|----------------|----------------|-----------|------|------|-------------|
| HY-EX-8V4-3/4 | VECTOR/VAC-CON | 8" | 3/4" | 4 | \$ 1,117.00 |
| HY-EX-8V8-3/4 | VECTOR/VAC-CON | 8" | 3/4" | 8 | \$ 1,115.00 |
| HY-EX-8V10-3/4 | VECTOR/VAC-CON | 8" | 3/4" | 10 | \$ 1,178.00 |
| HY-EX-8V4-1 | VECTOR/VAC-CON | 8" | 1 | 4 | \$ 1,111.00 |
| HY-EX-8V8-1 | VECTOR/VAC-CON | 8" | 1 | 8 | \$ 1,185.00 |
| HY-EX-8V10-1 | VECTOR/VAC-CON | 8" | 1 | 10 | \$ 1,196.00 |
| | | | | | |
| HY-EX-8C4-3/4 | CAMEL | 8" | 3/4" | 4 | \$ 1,062.00 |
| HY-EX-8C8-3/4 | CAMEL | 8" | 3/4" | 8 | \$ 1,117.00 |
| HY-EX-8C10-3/4 | CAMEL | 8" | 3/4" | 10 | \$ 1,144.00 |
| HY-EX-8C4-1 | CAMEL | 8" | 1 | 4 | \$ 1,063.00 |
| HY-EX-8C8-1 | CAMEL | 8" | 1 | 8 | \$ 1,128.00 |
| HY-EX-8C10-1 | CAMEL | 8" | 1 | 10 | \$ 1,150.00 |
| | | | | | |
| HY-EX-8J4-3/4 | VAC-ALL | 8" | 3/4" | 4 | \$ 1,062.00 |
| HY-EX-8J8-3/4 | VAC-ALL | 8" | 3/4" | 8 | \$ 1,117.00 |
| HY-EX-8J10-3/4 | VAC-ALL | 8" | 3/4" | 10 | \$ 1,144.00 |
| HY-EX-8J4-1 | VAC-ALL | 8" | 1 | 4 | \$ 1,063.00 |
| HY-EX-8J8-1 | VAC-ALL | 8" | 1 | 8 | \$ 1,128.00 |
| HY-EX-8J10-1 | VAC-ALL | 8" | 1 | 10 | \$ 1,150.00 |

HYH-EX-8V.....



HYH-EX-8C.....



HYH-EX-8J.....



ALL ARE AVAILABLE IN 6" TUBE SIZE. ADD "6" AFTER HY-EX. SAME PRICE AS 8"

SPECIALTY VACUUM FITTINGS/CLAMPS/ADAPTERS

8FFX6FH 8" FLAT FLANGE X 6" FLEX HOSE ADAPTER WITH RING TO CONNECT TO BAND LOCK CLAMP AND HOSE. YOUR HOSE WILL SWIVEL ON THIS ADAPTER. **HOSE NOT INCLUDED** \$ 226.00



5.75" O.D

CROWN NOZZLE REDUCERS/EXCAVATOR CUFFS / ELBOWS / TUBE CLAMPS

RCN8SS 8" X 5.5" Crown Nozzle Reducer 12" Long. Vector \$ 176.00
RCN8SSC 8" X 5.5" Crown Nozzle Reducer 12" Long. Camel female band lock x reduced crown \$ 215.00
RCN8SSV 8" X 5.5" Crown Nozzle Reducer 12" Long. Vac-All male band lock x reduced crown \$ 215.00



HYDRO-EXCAVATION REDUCER CUFFS

RCUFF8FF 8" X 6" Hydro Excavator Reducer Cuff 8" Flat Flange x 6" Kanaflex Cuff \$ 336.00
RCUFF8CT 8" X 6" Hydro Excavator Reducer Cuff 8" Bandlock Female (Camel) x 6" Kanaflex \$ 358.00
RCUFF8JT 8" X 6" Cuff Hydro Excavator Reducer Cuff 8" Bandlock Male (Vac-All) x 6" Kanaflex \$ 358.00
SCUFF8 8" X 6" Cuff Hydro Excavator Straight Cuff 8" Flat Flange x 8" Kanaflex Cuff \$ 347.00



Vac-All (M-Bandlock)



Camel (F-Bandlock)



6" O.D

ALUMINUM ELBOWS

CN908FF 8" Flange Short Radius 90° Elbow with Flat Flange x Crown Nozzle. All Aluminum \$ 484.00
EL98FF 8" Flange Short Radius 90° Elbow with Flat Flange x Flat Flange. All Aluminum \$ 396.00
EL458FF 8" Flange Short Radius 45° Elbow with Flat Flange x Flat Flange. All Aluminum \$ 396.00



CN908FF

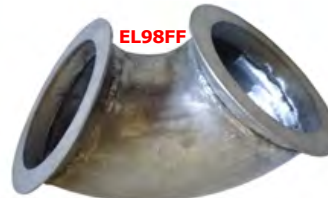

EL98FF

TRANSITION COUPLERS CHANGE ONE TYPE TUBE TO ANOTHER

- 8FFX8BLF** 8" FLAT FLANGE X 8" FEMALE BANDLOCK COUPLER. CONNECTS YOUR FLAT FLANGE TUBES TO YOUR BAND LOCK MALE COUPLING. ZINC PLATED \$ 237.00
- 8FFX8BLM** 8" FLAT FLANGE X 8" MALE BANDLOCK COUPLER. CONNECTS YOUR FLAT FLANGE TUBES TO YOUR BAND LOCK/CAMEL FEMALE COUPLING. ZINC PLATED \$ 237.00
- 6FFX6BLF** 6" FLAT FLANGE X 6" FEMALE BANDLOCK COUPLER. CONNECTS YOUR FLAT FLANGE TUBES TO YOUR BAND LOCK MALE COUPLING. ZINC PLATED \$ 226.00
- 6FFX6BLM** 6" FLAT FLANGE X 6" MALE BANDLOCK COUPLER. CONNECTS YOUR FLAT FLANGE TUBES TO YOUR BAND LOCK/CAMEL FEMALE COUPLING. ZINC PLATED \$ 226.00



TRANSITION REDUCER COUPLERS CHANGE ONE TYPE TUBE TO ANOTHER

- 8FFX6FF** 8" X 6" FLAT FLANGE REDUCER COUPLING. ZINC PLATED REDUCES YOUR 8" FLAT FLANGE TUBES TO 6" FLAT FLANGE TUBES \$ 226.00
- 8FFX6NPT** 8" FLAT FLANGE X 6" NPT THREADED TRANSITION COUPLING \$ 243.00
- 6BLFX4NPT** 6" BAND LOCK FEMALE X 4" MALE NPT THREAD \$ 226.00
- 8FFX6BLF** 8" FLAT FLANGE REDUCER TO 6" BAND LOCK FEMALE COUPLER REDUCES YOUR 8" FLAT FLANGE TUBES TO YOUR 6" MALE END BAND LOCK TUBES \$ 243.00
- 8FFX6BLM** 8" FLAT FLANGE REDUCER TO 6" BAND LOCK MALE COUPLER REDUCES YOUR 8" FLAT FLANGE TUBES TO YOUR 6" FEMALE END BAND LOCK TUBES \$ 243.00

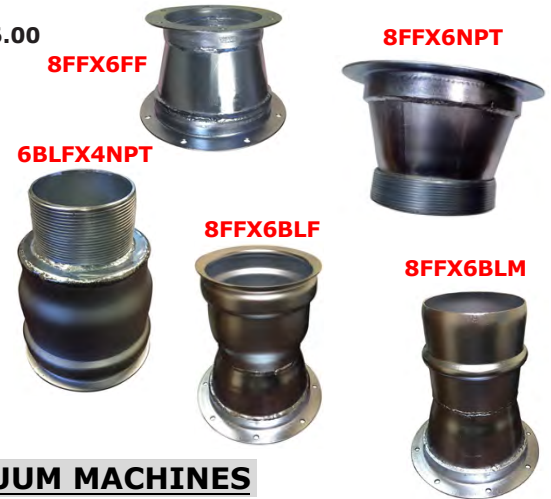

COUPLERS X HOSE SHANK END FOR YOUR VACUUM MACHINES

- 8FFX8HA** 8" FLAT FLANGE X 8" HOSE ADAPTER. CONNECTS YOUR 8" FLANGE VACUUM TUBES TO AN 8" KANAFLEX TYPE VACUUM HOSE \$ 193.00
- 6FFX6HA** 6" FLAT FLANGE X 6" HOSE ADAPTER. CONNECTS YOUR 6" FLAT FLANGE VACUUM TUBES TO AN 6" KANAFLEX TYPE VACUUM HOSE \$ 193.00
- 8FFX6HA** 8" FLAT FLANGE X 6" HOSE ADAPTER REDUCER. ALL STEEL WITH MOUNTING HOLES ZINC PLATED AND 7.5" OVERALL LENGTH (HOSE NOT INCLUDED) \$ 204.00



FLANGED DOUBLE HOSE SHANK REDUCER. 8" TO DOUBLE 4". OPENING FOR 4" HOSE.

- 8FFX44DD** 8" FLAT FLANGE X DOUBLE 4" HOSE CONNECTORS. ONE WITH SAFETY GRID INCLUDED FOR FREE AIR APPLICATION. 8" OVERALL LENGTH AND ZINC PLATED \$ 277.00
- 8FFX44ME** 8" FLAT FLANGE X DOUBLE 4" HOSE CONNECTOR WITH ONE 4" THREADED NPT MALE END \$336.00
- 336.00 COW-U-8V** 8" FLAT FLANGE X DOUBLE 2" AND 3" MALE, FEMALE CAM-LOCK ENDS \$ 1,045.00



- COW-U-8BLF** 8" MALE BANDLOCK X DOUBLE 2" AND 4" MALE, FEMALE CAM-LOCK ENDS \$ 1,078.00



- COW-U-8BLM** 8" FEMALE BANDLOCK X DOUBLE 2" AND 4" MALE, FEMALE CAM-LOCK ENDS \$ 1,078.00



INDUSTRIAL HYDRO VACUUM EQUIPMENT

Industrial Vacuum Tools And Attachments Make Your Life Safer and Easier For Your Employees

Do you feel safe when vacuuming? Do you want your safety to be in your hands? Don't get caught not having this item in your safety program. It is essential and necessary for all vacuum operators to have control of the force of vacuum.

Industrial Vacuum Users Will Easily See The Benefits Of The Safety Shutter Nozzle. It Allows You To Control The Flow Of Vacuum At The Point Of Entry. With Just A Push Of A Lever You Can Completely Release The Vacuum Flow Or You Can Control The Amount Of Suction To The End Of The Nozzle.



GPSS-4BL 4" SAFETY SHUTTER SUCTION NOZZLE FOR 4" FLEX HOSE **\$ 1,210.00**
 Designed for 4" Flex Hose That Will Slip Over The Smooth Connection End.
 Hose Will Swivel When Connected To Allow For Easy Positioning Of The Nozzle

GPSS-6BL 6" SAFETY SHUTTER SUCTION NOZZLE FOR 6" FLEX HOSE **\$ 1,430.00**
Same As Above But For 6" Flex Hose

GP-TRI TRI-POD FOR SAFETY SHUTTER SUCTION NOZZLES **\$ 182.00**
 The Tri-Pod Allows You To Set Up The Safety Nozzle For Hands Free Operation. It Works With The 4" or 6" Nozzle And Is Great For Pushing Material To The Inlet Essential Making It A One-Man Job

GP-EXT EXTENSION HANDLE FOR SAFETY **\$ 113.00**
 The 3' Extension Handle Connects To The Safety Nozzle Allowing You to Stand Up Straight To Take The Strain Off Your Back. Removing The Extension Handle Allows You To Use The Safety Nozzle In Tight Confined Areas.

GP-62 2' X 6" EXTENSION TUBE FOR GPSS-6BL **\$ 145.00**

GP-63 3' X 6" EXTENSION TUBE FOR GPSS-6BL **\$ 216.00**

GP-42 2' X 4" EXTENSION TUBE FOR GPSS-6BL **\$ 151.00**

GP-43 3' X 4" EXTENSION TUBE FOR GPSS-6BL **\$ 173.00**

All Aluminum tube extension. The suction inlet of the safety nozzle to suck underwater or in any area where you need to extend the inlet.

GP-DB-4 DUCKBILL NOZZLE FOR SAFETY SHUTTER SUCTION NOZZLE WITH 4" CONNECTION **\$ 308.00**

GP-DB-6 DUCKBILL NOZZLE FOR SAFETY SHUTTER SUCTION NOZZLE WITH 6" CONNECTION **\$ 330.00**

The Duckbill Nozzle is great for larger areas where extra width for liquids or slurry might be needed. Special end connects directly to end of safety nozzle with clamp

SAND TRAP

| | | |
|---------------|-----------------------------------------|------------------|
| SST-6 | 6" SAND TRAP WITH 25' LONG ROPE | \$ 182.00 |
| SST-8 | 8" SAND TRAP WITH 25' LONG ROPE | \$ 199.00 |
| SST-10 | 10" SAND TRAP WITH 25' LONG ROPE | \$ 211.00 |
| SST-12 | 12" SAND TRAP WITH 25' LONG ROPE | \$ 266.00 |
| SST-15 | 15" SAND TRAP WITH 25' LONG ROPE | \$ 356.00 |
| SST-18 | 18" SAND TRAP WITH 25' LONG ROPE | \$ 405.00 |
| SST-20 | 20" SAND TRAP WITH 25' LONG ROPE | \$ 545.00 |



HYDRAULIC ROOT SAW CUTTERS (MOTORS & KITS)

PUMA "HD" HIGH DISPLACEMENT HYDRAULIC ROOT SAW CUTTER

SOUTHLAND TOL Offers you the "PUMA" HD CUTTER MOTOR as our standard cutter. Don't be fooled by smaller blue motors that offer only a fraction of the power that this high displacement motor offers. It has higher cutter force to plow into roots, grease, protruding taps and other stoppages. These units fit our front flanged EZ-SKIDS as seen below with 4 bolts in front and 2 in the tail Nozzle.

- SHYM-1** 1" PUMA "HD" HIGHER DISPLACEMENT, 1" HYDRAULIC ROOT SAW MOTOR AND TAIL **\$ 1,295.00**
- SHYM-3/4** 3/4" NOZZLE PUMA "HD" HIGHER DISPLACEMENT, 3/4" HYDRAULIC ROOT SAW MOTOR AND TAIL NOZZLE **\$ 1,295.00**



PUMA ROOT CUTTER KIT AS FOLLOWS:

- SHYK-1** 1" PUMA "Heavy Duty" HIGHER DISPLACEMENT KIT **\$ 2,087.00**

- SHYK-3/4** 3/4" SAME KIT AS ABOVE BUT FOR 3/4" SEWER HOSE **\$ 2,087.00**

1" HYDRAULIC ROOT SAW MOTOR KIT INCLUDES:

- 4 Easy skids of 6", 8, 10" and 12".
- 4 HD concave root saws for 6", 8", 10" and 12"
- 1" HUB
- Arbor turn tool
- 1/4" Hex Allen Wrench
- 3/8-16 X 5/8 Hex Allen Wrench
- Tool box
- Maintenance instructions.



SHYK-1 PUMA KIT

The profile of this cutter is designed for lines from 6" and up. The motor can accommodate hose sizes of 3/4" and 1" with flow from 35 to 80 GPM and pressure from 2000 3000 PSI. Rated up to a maximum of 235 lbs. of torque.

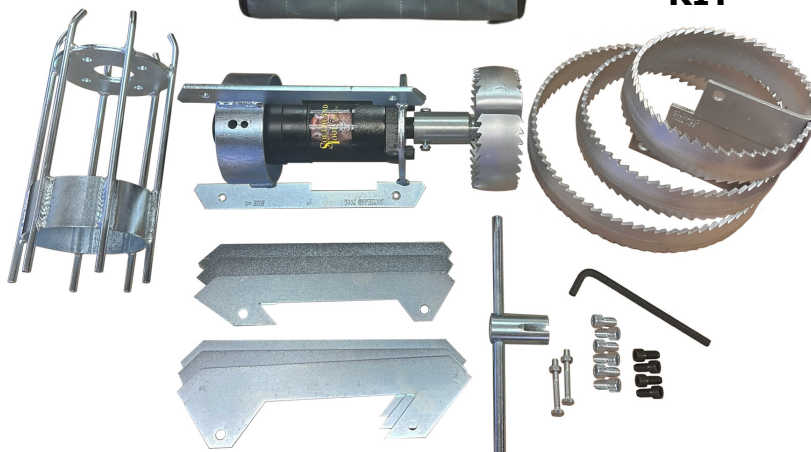

MOTOR-PARTS AND CHUCKS (FOR SAW BLADES AND CUTTERS SEE PAGES 29,30)

- SKP-1R** REPAIR KIT FOR PUMA MOTOR **\$ 209.00**

- TNPM** 1" PUMA TAIL NOZZLE REPLACEMENT ONLY **\$ 342.00**

- GERP-1** GEROTOR FOR PUMA MOTOR **\$ 391.00**

- ATT-1** ARBOR TURNING TOOL FOR ROOT CUTTER MOTOR **\$ 43.00**

- RSH-1A** 1" ROOT SAW HUB FOR ROOT CUTTER. FOR HEAVY DUTY 1/8" THICKNESS SAW BLADES **\$ 43.00**

- RSH-1B** 1" ROOT SAW HUB FOR ROOT CUTTER. FOR HEAVY DUTY 3/16" THICKNESS SAW **\$ 43.00**

- BLADES 3BHC-1** 3 BLADE CHUCK FOR 1" SHAFT ROOT CUTTER MOTOR **\$ 150.00**



Kit Includes:

- 3ea. Body Seal
- 1ea. Pressure Seal
- 1ea. Shaft Seal
- 1ea. Thrust Washer Seal
- 1ea. Thrust Bearing
- 1ea. Bearing Race Way



EZ ROOT CUTTER SKIDS FOR PUMA "HD" MOTORS

Easy ROOT CUTTER Skids are designed to skid over the motor and bolt down to the front flange and the 2 side bolts in the tail nozzle.

| | | |
|--------------|-------------------------------------------------------------------------------|------------------|
| SS-6 | 6" Easy ROOT CUTTER SKID WITH 6 RAILS for SHYM (Puma HD) Motors | \$ 154.00 |
| SS-8 | 8" Easy ROOT CUTTER SKID WITH 3 RAILS for SHYM (Puma HD) Motors | \$ 157.00 |
| SS-10 | 10" EZ Root Cutter Skid (FINS ONLY) for SHYM (Puma HD) Motors | \$ 164.00 |
| SS-12 | 12" EZ Root Cutter Skid (FINS ONLY) for SHYM (Puma HD) Motors | \$ 172.00 |
| SS-15 | 15" EZ Root Cutter Skid (FINS ONLY) for SHYM (Puma HD) Motors | \$ 176.00 |
| SS-18 | 18" Easy ROOT CUTTER SKID WITH 3 RAILS for SHYM (Puma HD) Motors | \$ 230.00 |
| SS-20 | 20" Easy ROOT CUTTER SKID WITH 3 RAILS for SHYM (Puma HD) Motors | \$ 303.00 |
| SS-22 | 22" Easy ROOT CUTTER SKID WITH 3 RAILS for SHYM (Puma HD) Motors | \$ 363.00 |
| SS-24 | 24" Easy ROOT CUTTER SKID WITH 3 RAILS for SHYM (Puma HD) Motors | \$ 399.00 |



DONUT SKIDS

| | | |
|-----------------|-----------------------------------------------|-----------------|
| S950-108 | FRONT 4 BOLT SKID DONUT FOR PUMA MOTOR | \$ 50.00 |
| S950-109 | REAR 2 BOLT SKID DONUT FOR PUMA MOTOR | \$ 50.00 |



TAP/CALCIUM CUTTERS (TIER 2 PRODUCT)

| | | |
|------------------|----------------------------------------------------------------------------------------------------------------------------------------------|--------------------|
| DTC-6-K-1 | Hi-Torque 6" Tap Cutter Kit, includes, S906M-1 Motor, STSS-6 Skid DTC-6 Diamond Tap Cutter, Tool Box, Turn Tool, Allen Wrench, Bolts. | \$ 3,200.00 |
| DTC-8-K-1 | Hi-Torque 8" Tap Cutter Kit, includes, S906M-1 Motor, STSS-8 Skid DTC-8 Diamond Tap Cutter, Tool Box, Turn Tool, Allen Wrench, Bolts. | \$ 3,700.00 |



DIAMOND TAP CUTTERS

| | | |
|---------------|-------------------------------|--------------------|
| DTC-6 | 6" DIAMOND TAP CUTTER | \$ 1,498.00 |
| DTC-8 | 8" DIAMOND TAP CUTTER | \$ 2,033.00 |
| DTC-10 | 10" DIAMOND TAP CUTTER | \$ 2,568.00 |
| DTC-12 | 12" DIAMOND TAP CUTTER | \$ 2,889.00 |
| DTC-15 | 15" DIAMOND TAP CUTTER | \$ 3,424.00 |



PVC TAP CUTTER

| | | |
|---------------|---------------------------|--------------------|
| CTS-6 | 6" PVC TAP CUTTER | \$ 744.00 |
| CTS-8 | 8" PVC TAP CUTTER | \$ 1,155.00 |
| CTS-10 | 10" PVC TAP CUTTER | \$ 1,386.00 |
| CTS-12 | 12" PVC TAP CUTTER | \$ 1,921.00 |
| CTS-15 | 15" PVC TAP CUTTER | \$ 1,995.00 |
| CTS-18 | 18" PVC TAP CUTTER | \$ 2,402.00 |

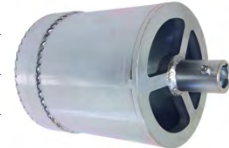

ARROW DIAMOND TIPPED CUTTER (CALCIUM CARBONATE CUTTER)

| | | |
|---------------|---------------------------------|--------------------|
| ADC-6 | 6" ARROW DIAMOND CUTTER | \$ 2,287.00 |
| ADC-8 | 8" ARROW DIAMOND CUTTER | \$ 3,205.00 |
| ADC-10 | 10" ARROW DIAMOND CUTTER | \$ 3,478.00 |
| ADC-12 | 12" ARROW DIAMOND CUTTER | \$ 4,013.00 |
| ADC-15 | 15" ARROW DIAMOND CUTTER | \$ 4,815.00 |

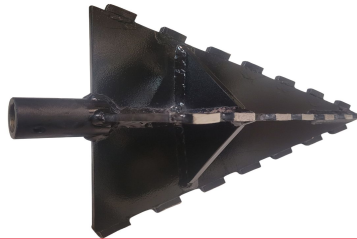

SEPTIC CLEANING TOOLS (All are fitted with a 3/4" Female NPT Pipe connection)

| | | |
|---------------|-----------------------------------------------|------------------|
| SV-1HD | 9" ANGLED SLUDGE HOE WITH 2 HOLES | \$ 88.00 |
| SV-2HD | 15" ANGLED SLUDGE HOE WITH 3 HOLES | \$ 94.00 |
| SV-3HD | 9" FLAT SLUDGE SPUD | \$ 83.00 |
| SV-4HD | 15" FLATSLUDGE SPUD | \$ 94.00 |
| SV-5HD | 9" CURVED SPUD | \$ 88.00 |
| SV-6HD | 15" CURVED SPUD | \$ 99.00 |
| SV-7HD | 16" TANK SCRAPER (HALF MOON FOR TANKS) | \$ 99.00 |
| SV-8HD | 12" SLUDGE RAKE WITH 2 HOLES AND TEETH | \$ 105.00 |



| | | |
|-------------|--------------------------------------------------------------|-----------------|
| FE-1 | ADAPTER TO CONNECT SEPTIC CLEANING TOOLS TO FIBERGLASS POLES | \$ 39.00 |
|-------------|--------------------------------------------------------------|-----------------|



SRRC-1H SUPER "RED HOT" EXTENDED DUTY HYDRAULIC ROOT CUTTER MOTORS

SRRC-1H 1" ROUND BODY SUPER "RED HOT" HEAVY DUTY BEARING HYDRAULIC ROOT SAW MOTOR. **\$ 1,455.00**
 This motor has been specially machined for a Heavy Duty thrust bearing that performs better for extended life, smooth running and reduced maintenance problems. This larger steel bearing absorbs the constant pounding of the shaft when plowing into root masses and stoppages. This motor fits all round body skids including Patriot and Smart Cutters.

SRRC-3/4H 3/4" SAME AS ABOVE BUT FOR 3/4" HOSE. **\$ 1,455.00**



KITS

SRRK-1H 1" RED HOT KIT "Heavy Duty" **HIGHER DISPLACEMENT** **\$ 2,301.00**
SRRK-3/4H 3/4" SAME AS ABOVE BUT FOR 3/4" HOSE. **\$ 2,301.00**

1" HYDRAULIC RED HOT ROOT SAW MOTOR KIT INCLUDES:

- 4 RBS skids of 6", 8, 10" and 12".
- 4 HD concave root saws for 6", 8", 10" and 12"
- 1" HUB
- Arbor turn tool
- 1/4" Hex Allen Wrench
- 3/8-16 X 3/8 Hex Allen Wrench
- Tool box
- Maintenance instructions.

**SRRK-1H
RED HOT KIT**



RED HOT The round profile of the cutters allows it to enter sewer lines from 4" and up. The motor can accommodate hose sizes of 1" and 3/4" with flow from 35 to 80 gpm and pressure from 2000 to 3000 psi. Rated up to maximum of 235 lbs. of torque and 175 lbs. at continuous operation. This tool has the power to clean while the bearing can take a beating and keep on ticking. This motor be as all competitor motors

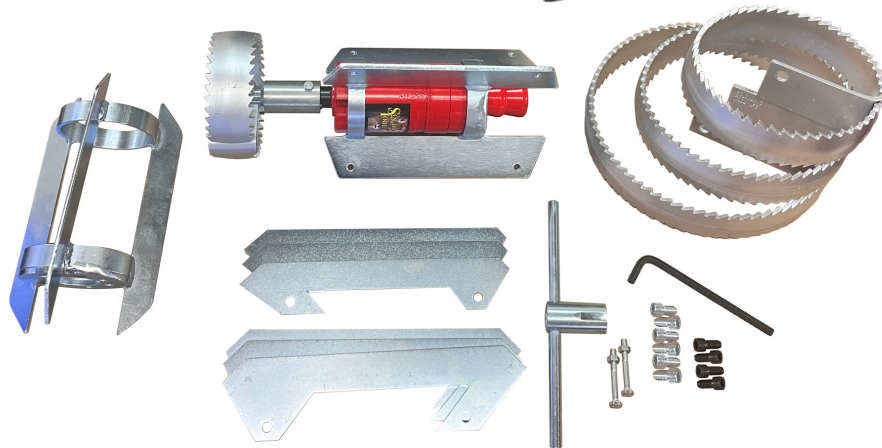

MOTOR-PARTS AND CHUCKS (FOR SAW BLADES AND CUTTERS SEE PAGES 29,30)

SKP-1RH REPAIR KIT FOR SRRC-1H MOTOR **\$ 209.00**

TNPM 1" SECA TAIL NOZZLE REPLACEMENT ONLY **\$ 342.00**

GERP-1 GEROTOR FOR SRRC-1H MOTOR **\$ 391.00**

ATT-1 ARBOR TURNING TOOL FOR ROOT CUTTER MOTOR **\$ 43.00**

RSH-1A 1" ROOT SAW HUB FOR ROOT CUTTER. FOR HEAVY DUTY 1/8" THICKNESS SAW BLADES **\$ 43.00**

RSH-1B 1" ROOT SAW HUB FOR ROOT CUTTER. FOR HEAVY DUTY 3/16" THICKNESS SAW BLADES **\$ 43.00**

3BHC-1 3 BLADE CHUCK FOR 1" SHAFT ROOT CUTTER MOTOR **\$ 150.00**



Kit Includes:

- 3ea. Body Seal
- 1ea. Pressure Seal
- 1ea. Shaft Seal
- 1ea. Thrust Washer Seal
- 1ea. HD Thrust Bearing
- 1ea. Bearing Race Way

TIER 2 PRODUCT

SRRC-1P ROUND BODY SUPER "GREEN MEANIE" HYDRAULIC MOTOR

- SRRC-1P** 1" ROUND BODY **SUPER GREEN MEANIE 175lb.** Torque motor replaces your patriot and smart cutters. This unit fits all of your patriot and smart cutter style skids Equipment Company **\$ 1,338.00**
- SRRC-3/4P** 3/4" **KIT SAME AS ABOVE BUT FOR 3/4" HOSE.** **\$ 1,338.00**



- SRRK-1** 1" **SUPER GREEN MEANIE COMPLETE KIT** **\$ 2,242.00**
- SRRK-3/4** 3/4" **SUPER GREEN MEANIE COMPLETE KIT** **\$ 2,242.00**

Super Green Meanie Root Saw Motor Kit Includes:

- 4 Easy skids of 6", 8, 10" and 12".
- 4 HD concave root saws for 6", 8", 10" and 12"
- 1" HUB
- Arbor turn tool
- 1/4 Hex Allen Wrench
- 3/8-16 X 5/8 Hex Allen Wrench
- Tool box
- Maintenance instructions.

SRRK-1 Super Green Meanie KIT



SOUTHLAND TOOL "SUPER GREEN MEANIE" Round Body root cutting motor is a superior cutting and ripping tool for cleaning roots, cutting taps and destroying other debris and buildup found in all sewer lines. The round profile of this motor allows it to be used in 4" pipes and up for either 3/4" or 1" Hose. Flow from 35 to 80 gpm and pressure from 1750 to 3000. 235 lbs. of torque. buy this motor only to replace your worn out Patriot or smart cutter green motor and use the green skids you have or buy our skids, standard or wheeled.

MOTOR-PARTS AND CHUCKS (FOR SAW BLADES AND CUTTERS SEE PAGES 29,30)

- SKP-1R** REPAIR KIT FOR FOR SRRC-1P MOTOR **\$ 209.00**

- TNSM** 1" SECA TAIL NOZZLE REPLACEMENT ONLY **\$ 342.00**

- GERP-1** GEROTOR FOR SRRC-1PMOTOR **\$ 391.00**

- ATT-1** ARBOR TURNING TOOL FOR ROOT CUTTER MOTOR **\$ 43.00**

- RSH-1A** 1" ROOT SAW HUB FOR ROOT CUTTER. FOR HEAVY DUTY 1/8" THICKNESS SAW BLADES **\$ 43.00**

- RSH-1B** 1" ROOT SAW HUB FOR ROOT CUTTER. FOR HEAVY DUTY 3/16" THICKNESS SAW BLADES **\$ 43.00**

- 3BHC-1** 3 BLADE CHUCK FOR 1" SHAFT ROOT CUTTER MOTOR **\$ 150.00**



Kit Includes:

- 3ea. Body Seal
- 1ea. Pressure Seal
- 1ea. Shaft Seal
- 1ea. Thrust Washer Seal
- 1ea. Thrust Bearing
- 1ea. Bearing Race Way



TIER 2 PRODUCT

SRRK-14-15W ROUND BODY SUPER "GREEN MACHINE" HYDRAULIC MOTOR CITIZEN KIT

SRRK-1-4-15W 1" CITIZEN ROUND BODY "SUPER GREEN MACHINE" WHEELED KIT for pipe from 4" to 15" **\$ 3,317.00**

1" Hydraulic Super Green Meanie Root Saw Motor Citizen Kit includes:

- 6 HD concave root saws for 4, 6", 8", 10", 12 and 15"
- 4" Round ring set
- 6" Skid
- 8" - 10" adjustable wheeled skid
- 12" - 15" wheeled skid
- 1" HUB
- Arbor turn tool
- ¼ Hex Allen Wrench
- Tool box
- Maintenance instructions.



SRRK-1-4-15W
CITIZEN KIT

MOTOR-PARTS AND CHUCKS (FOR SAW BLADES AND CUTTERS SEE PAGES 29,30)

SKP-1R REPAIR KIT FOR FOR SRRK-1P MOTOR **\$ 209.00**

TNSM 1" SECA TAIL NOZZLE REPLACEMENT ONLY **\$ 342.00**

GERP-1 GEROTOR FOR SRRK-1P MOTOR **\$ 391.00**

ATT-1 ARBOR TURNING TOOL FOR ROOT CUTTER MOTOR **\$ 43.00**

RSH-1A 1" ROOT SAW HUB FOR ROOT CUTTER. FOR HEAVY DUTY 1/8" THICKNESS SAW BLADES **\$ 43.00**

RSH-1B 1" ROOT SAW HUB FOR ROOT CUTTER. FOR HEAVY DUTY 3/16" THICKNESS SAW BLADES **\$ 43.00**



- Kit Includes:**
- 3ea. Body Seal
 - 1ea. Pressure Seal
 - 1ea. Shaft Seal
 - 1ea. Thrust Washer Seal
 - 1ea. Thrust Bearing
 - 1ea. Bearing Race Way

SKIDS FOR ROUND BODY "RED" AND "GREEN" ROOT CUTTER MOTORS

- | | | |
|---------------|-------------------------------------------------|------------------|
| RBS-4 | 4" RING SET FOR ROUND BODY ROOT CUTTER | \$ 150.00 |
| RBS-6 | 6" SKID FOR ROUND BODY ROOT CUTTER | \$ 142.00 |
| RBS-8 | 8" SKID FOR ROUND BODY ROOT CUTTER | \$ 156.00 |
| RBS-10 | 10" SKID FINS FOR ROUND BODY ROOT CUTTER | \$ 162.00 |
| RBS-12 | 12" SKID FINS FOR ROUND BODY ROOT CUTTER | \$ 173.00 |
| RBS-15 | 15" SKID FINS FOR ROUND BODY ROOT CUTTER | \$ 222.00 |
| RBS-18 | 18" SKID FOR ROUND BODY ROOT CUTTER | \$ 260.00 |
| RBS-20 | 20" SKID FOR ROUND BODY ROOT CUTTER | \$ 330.00 |
| RBS-24 | 24" SKID FOR ROUND BODY ROOT CUTTER | \$ 383.00 |



APS-1 8" - 10" ADJUSTABLE WHEELED SKID FOR ROUND BODY MOTORS **\$ 395.00**

APS-2 12" - 15" ADJUSTABLE WHEELED SKID FOR ROUND BODY MOTORS **\$ 474.00**



"HI-TORQUE" S906 HEAVY DUTY CONTRACTOR DUTY HYDRAULIC ROOT CUTTER

Southland Tools' S906M is the largest and most powerful of the Southland Tool Hydraulic motor line up.

| | | |
|-------------------|------------------------------------------------------------------------|--------------------|
| S906M-1 | HI-TORQUE HYDRAULIC ROOT CUTTER MOTOR ONLY FOR 1" SEWER HOSE HI-TORQUE | \$ 1,496.00 |
| S906M-3/4 | HYDRAULIC ROOT CUTTER MOTOR ONLY FOR 3/4" SEWER HOSE HI-TORQUE | \$ 1,496.00 |
| S906M-1.25 | HYDRAULIC ROOT CUTTER MOTOR ONLY FOR 1.25" SEWER HOSE | \$ 1,496.00 |



HI-TORQUE HYDRAULIC ROOT SAW CUTTER KITS AND MOTORS

| | | |
|------------------|-----------------------------------------|--------------------|
| S906K-1 | "HI-TORQUE" HYDRAULIC ROOT SAW KIT | \$ 2,783.00 |
| S906K-3/4 | SAME AS ABOVE BUT FOR 3/4" HOSE. | \$ 2,783.00 |

1" Hi-Torque" Hydraulic root saw motor includes:

- 4 Skids, for 6", 8", 10" and 12".
- 4 HD concave root saws for 6", 8", 10" and 12"
- 1" HUB
- Arbor turn tool
- 1/4 Hex Allen Wrench
- 3/8-16 X 5/8 Hex Allen Wrench
- Tool box
- Maintenance instructions.



**S906K-1
HI-TORQUE
KIT**

This "Hi-Torque" motor features a Gerotor design that internally lowers resistance and allows the motor to operate more efficiently while producing maximum cutting results. The S906M Series of motors have all steel thrust bearing with robust roller that can handle the higher pressure loads of larger pumps and heavy cleaning in larger lines. This motor has long been referred to as the "Contractor Duty" motor as it holds up well under intense use for longer periods of time. Designed for lines from 6" to 30" the motor comes in 3/4", 1" and 1.25". It can handle flows of 10 to 170 gpm and pressure of 1500 to 3000 psi. It is rated to a maximum torque of 288 lbs. and 220 lbs. of continuous torque which is required for cutting taps in large sizes.

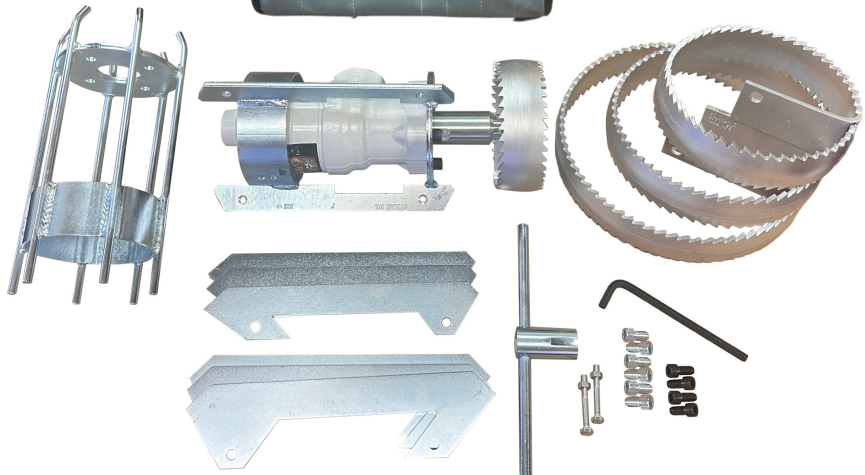

MOTOR-PARTS AND CHUCKS (FOR SAW BLADES AND CUTTERS SEE PAGES 29,30)

SK-1R REPAIR KIT FOR HI TORQUE MOTOR **\$ 209.00**

TN906-1M 1" HIGH TORQUE TAIL NOZZLE REPLACEMENT ONLY **\$ 342.00**

GER-1-S906 GE-ROLLER FOR 906 AK MOTOR **\$ 391.00**

ATT-1 ARBOR TURNING TOOL FOR ROOT CUTTER MOTOR **\$ 43.00**

RSH-1A 1" ROOT SAW HUB FOR ROOT CUTTER. FOR HEAVY DUTY 1/8" THICKNESS SAW BLADES **\$ 43.00**

RSH-1B 1" ROOT SAW HUB FOR ROOT CUTTER. FOR HEAVY DUTY 3/16" THICKNESS SAW BLADES **\$ 43.00**

3BHC-1 3 BLADE CHUCK FOR 1" SHAFT ROOT CUTTER MOTOR **\$ 150.00**

- Kit Includes:**
- 3 Body Seals
 - 1 Pressure Seal
 - 1 Shaft Seal
 - 1 Thrust Washer Seal
 - 5 Bolt Crush Washer
 - 1 Thrust Bearing
 - 1 Bearing Race Way

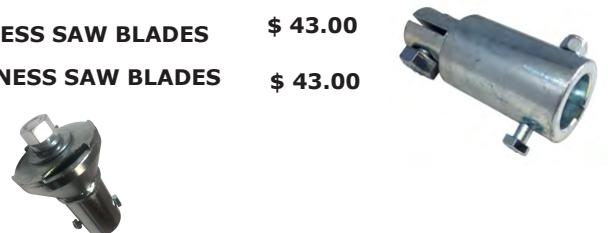

TIER 2 PRODUCT

For Recyclers ! HI TORQUE "KINETICS" CORROSION RESISTANT MOTOR

The S906M-AK SERIES OF MOTORS IS SOUTHLAND FLAGSHIP MOTOR UP TO 170 GPM

- | | | |
|----------------------|-----------------------------------------------------------------|--------------------|
| S906M-1-AK | HI-TORQUE HYDRAULIC ROOT CUTTER MOTOR ONLY 1" SEWER HOSE | \$ 1,969.00 |
| S906M-3/4-AK | HI-TORQUE HYDRAULIC ROOT CUTTER MOTOR ONLY 3/4" SEWER HOSE | \$ 1,969.00 |
| S906M-1.25-AK | HI-TORQUE HYDRAULIC ROOT CUTTER MOTOR ONLY FOR 1.25" SEWER HOSE | \$ 2,205.00 |
| S906M-1.50-AK | HI-TORQUE HYDRAULIC ROOT CUTTER MOTOR ONLY FOR 1.50" SEWER HOSE | \$ 2,321.00 |

ADVANCED KINETICS INFUSION

This motor is built as the same platform as the standard S-906M motor but has an infusion process at the cellular level applied to the internal parts that make it silky smooth to turn and ideal for recycler units. This process improves hydraulic performance and almost eliminates internal corrosion. This process known as "Advanced Kinetics" used a patented finish of Salt Bath Nitriding that improves coefficient allowing parts to run smoother which reduces drag, saves water and increases productivity. Known to sit for weeks with water inside and still turns.



HI-TORQUE MOTOR-PARTS AND CHUCKS (FOR SAW BLADES AND CUTTERS SEE PAGES 29,30)

SKP-906 1" REPAIR KIT FOR 906AK MOTOR **\$ 209.00**



Kit Includes:

- 3 Body Seals
- 1 Pressure Seal
- 1 Shaft Seal
- 1 Thrust Washer Seal
- 5 Bolt Crush Washer
- 1 Thrust Bearing

TN906-1M 1" 906AK TAIL NOZZLE REPLACEMENT ONLY **\$ 342.00**



GER-S906-AK GE-ROLLER FOR 906 AK MOTOR **\$ 391.00**



ATT-1 ARBOR TURNING TOOL FOR ROOT CUTTER MOTOR **\$ 43.00**



RSH-1A 1" ROOT SAW HUB FOR ROOT CUTTER. FOR HEAVY DUTY 1/8" THICKNESS SAW BLADES **\$ 43.00**



RSH-1B 1" ROOT SAW HUB FOR ROOT CUTTER. FOR HEAVY DUTY 3/16" THICKNESS SAW BLADES **\$ 43.00**

SHAMROCK STYLE 2-PART SKIDS FOR HI-TORQUE S906 ROOT CUTTERS

- | | | |
|-----------------|---------------------------------|------------------|
| STSS-6S | 6" SHAMROCK STYLE 2-PART SKIDS | \$ 158.00 |
| STSS-8S | 8" SHAMROCK STYLE 2-PART SKIDS | \$ 168.00 |
| STSS-10S | 10" SHAMROCK STYLE 2-PART SKIDS | \$ 173.00 |
| STSS-12S | 12" SHAMROCK STYLE 2-PART SKIDS | \$ 179.00 |
| STSS-15S | 15" SHAMROCK STYLE 2-PART SKIDS | \$ 184.00 |
| STSS-18S | 18" SHAMROCK STYLE 2-PART SKIDS | \$ 215.00 |
| STSS-20S | 20" SHAMROCK STYLE 2-PART SKIDS | \$ 257.00 |
| STSS-22S | 22" SHAMROCK STYLE 2-PART SKIDS | \$ 315.00 |
| STSS-24S | 24" SHAMROCK STYLE 2-PART SKIDS | \$ 341.00 |

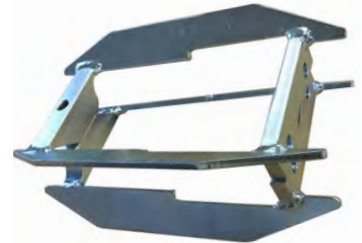

SKIDS FOR HI-TORQUE S906M STYLE ROOT CUTTERS

- | | | |
|----------------|--------------------------------------------|------------------|
| STSS-6 | 6" EASY ROOT CUTTER SKID WITH 6 RAILS | \$ 142.00 |
| STSS-8 | 8" EASY ROOT CUTTER SKID WITH 3 RAILS | \$ 145.00 |
| STSS-10 | 10" EASY ROOT CUTTER SKID FINS ONLY | \$ 149.00 |
| STSS-12 | 12" EASY ROOT CUTTER SKID FINS ONLY | \$ 152.00 |
| STSS-15 | 15" EASY ROOT CUTTER SKID FINS ONLY | \$ 155.00 |
| STSS-18 | 18" EASY ROOT CUTTER SKID WITH 3 RAILS | \$ 210.00 |
| STSS-20 | 20" EASY ROOT CUTTER SKID WITH 3 RAILS | \$ 263.00 |
| STSS-22 | 22" EASY ROOT CUTTER SKID WITH 3 RAILS | \$ 294.00 |
| STSS-24 | 24" EASY ROOT CUTTER SKID WITH 3 RAILS | \$ 362.00 |

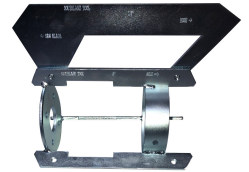

Check Out This New Cutter !!

New and Improved Tiger Tooth Lateral Root Cutter

TIGER TOOTH ROOT CUTTER WITH MORE TORQUE AND LOWER SPEED TO POWER TROUGH ROOT AND GREASE STOPAGES IN LINES FROM 3" TO 8" S903M-1 LATERAL MOTOR ONLY. PLEASE SECIFY WITH 1/2", 3/4" OR 1" \$ 983.00



- S903K-1 1" LATERAL MOTOR COMPLETE KIT \$ 1,575.00**
- S903K-1/2 SAME AS ABOVE BUT FOR 1/2" HOSE. \$ 1,575.00**
- S903K-3/4 SAME AS ABOVE BUT FOR 3/4" HOSE \$ 1,575.00**

Tiger Tooth Hydraulic root saw motor includes:

- 3 Skids of 4", 6", 8,
- 2 HD concave root saws for 4", 8"
- 5/8" HUB
- Arbor turn tool
- 1/4" Hex Allen Wrench
- 3/8-16 X 5/8 Hex Allen Wrench
- Tool box
- Maintenance instructions.

These motors are new and improved with high 410 inch pounds of torque. For use with your 1/2", 3/4" and 1" hose. They rotate at 400 rpm and are designed for 1500 to 400 psi and from 18 to 80 gpm. This new and improved Tiger Tooth Root Cutter has twice the cleaning and twice the power of our previous lateral motors.



S903K-1 Tiger Tooth Kit

TIGER TOOTH MOTOR-PARTS AND CHUCKS

- SKP-903 REPAIR KIT FOR TIGER TOOTH MOTOR \$ 209.00**
- TN903M 1" TIGER TOOTH TAIL NOZZLE REPLACEMENT ONLY \$ 342.00**
- GERTT-1 GEROTOR FOR TIGER TAIL MOTOR \$ 391.00**
- RSH-5B 5/8" HUB FOR HYDRAULIC ROOT CUTTER SAW FOR 1/8" SAW BLADE \$ 43.00**
- RSH-5C 5/8" HUB FOR HYDRAULIC ROOT CUTTER SAW FOR 3/16 SAW BLADE \$ 43.00**
- 3BHC-2 3 BLADE CHUCK FOR 5/8" SHAFT ROOT CUTTER MOTOR \$ 150.00**

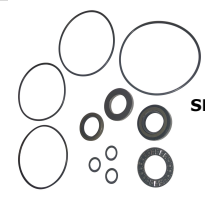

SK-1R SEAL KIT
 4 Body Seals
 1 Pressure Seal
 1 Shaft Seal
 3 Washers
 1 Thrust Bearing
 1 Bearing Race Way

ROOT CUTTER SKIDS AND RINGS FOR PURPLE DEBRIS EATER LATERAL CUTTER MOTOR

- LKS-3 LATERAL ROOT CUTTER SKID RING SET FOR 3" PIPE \$ 79.00**
- LKS-4 LATERAL ROOT CUTTER SKID FOR 4" PIPE \$ 88.00**
- LKS-6 LATERAL ROOT CUTTER SKID FOR 6" PIPE \$ 107.00**
- LKS-8 LATERAL ROOT CUTTER SKID FOR 8" PIPE \$ 121.00**



ROOT SAW BLADES ONLY

STANDARD CONCAVE ROOT SAW BLADES 1/8" THICK

| | | | |
|---------|-----|-----------------------------|-----------|
| CRS-3B | 3" | CONCAVE ROOT SAW BLADE ONLY | \$ 132.00 |
| CRS-4B | 4" | CONCAVE ROOT SAW BLADE ONLY | \$ 147.00 |
| CRS-6B | 6" | CONCAVE ROOT SAW BLADE ONLY | \$ 162.00 |
| CRS-8B | 8" | CONCAVE ROOT SAW BLADE ONLY | \$ 177.00 |
| CRS-10B | 10" | CONCAVE ROOT SAW BLADE ONLY | \$ 215.00 |
| CRS-12B | 12" | CONCAVE ROOT SAW BLADE ONLY | \$ 249.00 |
| CRS-15B | 15" | CONCAVE ROOT SAW BLADE ONLY | \$ 310.00 |

ANY SAW IS AVAILABLE WITH A WELDED ON 1" ARBOR HUB FOR \$60.00 ADD "WH" TO PART NUMBER

STANDARD FLAT ROOT SAW BLADES 1/8" THICK

| | | | |
|---------|-----|-----------------------------------|-----------|
| FRS-3B | 3" | STANDARD FLAT ROOT SAW BLADE ONLY | \$ 132.00 |
| FRS-4B | 4" | STANDARD FLAT ROOT SAW BLADE ONLY | \$ 147.00 |
| FRS-6B | 6" | STANDARD FLAT ROOT SAW BLADE ONLY | \$ 162.00 |
| FRS-8B | 8" | STANDARD FLAT ROOT SAW BLADE ONLY | \$ 177.00 |
| FRS-10B | 10" | STANDARD FLAT ROOT SAW BLADE ONLY | \$ 215.00 |
| FRS-12B | 12" | STANDARD FLAT ROOT SAW BLADE ONLY | \$ 249.00 |
| FRS-15B | 15" | STANDARD FLAT ROOT SAW BLADE ONLY | \$ 310.00 |

ANY SAW IS AVAILABLE WITH A WELDED ON 1" ARBOR HUB FOR \$60.00 ADD "WH" TO PART NUMBER

HEAVY DUTY CONCAVE ROOT SAW BLADES 3/16" THICK

| | | | |
|----------|-----|--------------------------------|-----------|
| HCRS-3B | 3" | HD CONCAVE ROOT SAW BLADE ONLY | \$ 134.00 |
| HCRS-4B | 4" | HD CONCAVE ROOT SAW BLADE ONLY | \$ 151.00 |
| HCRS-5B | 5" | HD CONCAVE ROOT SAW BLADE ONLY | \$ 166.00 |
| HCRS-6B | 6" | HD CONCAVE ROOT SAW BLADE ONLY | \$ 182.00 |
| HCRS-8B | 8" | HD CONCAVE ROOT SAW BLADE ONLY | \$ 198.00 |
| HCRS-10B | 10" | HD CONCAVE ROOT SAW BLADE ONLY | \$ 224.00 |
| HCRS-12B | 12" | HD CONCAVE ROOT SAW BLADE ONLY | \$ 249.00 |
| HCRS-15B | 15" | HD CONCAVE ROOT SAW BLADE ONLY | \$ 320.00 |
| HCRS-18B | 18" | HD CONCAVE ROOT SAW BLADE ONLY | \$ 360.00 |
| HCRS-20B | 20" | HD CONCAVE ROOT SAW BLADE ONLY | \$ 387.00 |

ANY SAW IS AVAILABLE WITH A WELDED ON 1" ARBOR HUB FOR \$60.00 ADD "WH" TO PART NUMBER

HEAVY DUTY FLAT ROOT SAW BLADES 3/16" THICK

| | | | |
|----------|-----|--------------------------|-----------|
| HFRS-3B | 3" | FLAT ROOT SAW BLADE ONLY | \$ 134.00 |
| HFRS-4B | 4" | FLAT ROOT SAW BLADE ONLY | \$ 151.00 |
| HFRS-5B | 5" | FLAT ROOT SAW BLADE ONLY | \$ 166.00 |
| HFRS-6B | 6" | FLAT ROOT SAW BLADE ONLY | \$ 182.00 |
| HFRS-8B | 8" | FLAT ROOT SAW BLADE ONLY | \$ 198.00 |
| HFRS-10B | 10" | FLAT ROOT SAW BLADE ONLY | \$ 224.00 |
| HFRS-12B | 12" | FLAT ROOT SAW BLADE ONLY | \$ 249.00 |
| HFRS-15B | 15" | FLAT ROOT SAW BLADE ONLY | \$ 320.00 |
| HFRS-18B | 18" | FLAT ROOT SAW BLADE ONLY | \$ 360.00 |
| HFRS-20B | 20" | FLAT ROOT SAW BLADE ONLY | \$ 387.00 |

ANY SAW IS AVAILABLE WITH A WELDED ON 1" ARBOR HUB FOR \$60.00 ADD "WH" TO PART NUMBER

SPIRAL ROOT SAW BLADES 5/32" THICK

| | | | |
|---------|-----|----------------------------------------|-----------|
| SRS-4B | 4" | SPIRAL ROOT SAW FOR 4" PIPE BLADE ONLY | \$ 168.00 |
| SRS-6B | 6" | SPIRAL ROOT SAW FOR 4" PIPE BLADE ONLY | \$ 246.00 |
| SRS-8B | 8" | SPIRAL ROOT SAW FOR 4" PIPE BLADE ONLY | \$ 295.00 |
| SRS-10B | 10" | SPIRAL ROOT SAW FOR 4" PIPE BLADE ONLY | \$ 313.00 |
| SRS-12B | 12" | SPIRAL ROOT SAW FOR 4" PIPE BLADE ONLY | \$ 344.00 |
| SRS-15B | 15" | SPIRAL ROOT SAW FOR 4" PIPE BLADE ONLY | \$ 361.00 |

ANY SAW IS AVAILABLE WITH A WELDED ON 1" ARBOR HUB FOR \$60.00 ADD "WH" TO PART NUMBER

COLORADO STYLE SAW BLADE 3/16" THICK

| | | | |
|----------|----|----------------------------|-----------|
| H-CRS-7C | 7" | OVERLAP COLORADO WHITE SAW | \$ 243.00 |
|----------|----|----------------------------|-----------|



CARBIDE SAW BLADES - LARGE DIAMETER

CARBIDE TIPPED CONCAVE ROOT SAWS

| | | | |
|---------------|------------|---------------------------------------------------------|------------------|
| SCS-6 | 6" | CARBIDE TIPPED CONCAVE ROOT SAW BLADE ONLY. 3/16" THICK | \$ 385.00 |
| SCS-8 | 8" | CARBIDE TIPPED CONCAVE ROOT SAW BLADE ONLY. 3/16" THICK | \$ 446.00 |
| SCS-10 | 10" | CARBIDE TIPPED CONCAVE ROOT SAW BLADE ONLY. 3/16" THICK | \$ 534.00 |
| SCS-12 | 12" | CARBIDE TIPPED CONCAVE ROOT SAW BLADE ONLY. 3/16" THICK | \$ 653.00 |
| SCS-15 | 15" | CARBIDE TIPPED CONCAVE ROOT SAW BLADE ONLY. 3/16" THICK | \$ 846.00 |



CARBIDE TIPPED FLAT ROOT SAWS

| | | | |
|----------------|------------|------------------------------------------------------|------------------|
| SCFS-6 | 6" | CARBIDE TIPPED FLAT ROOT SAW BLADE ONLY. 3/16" THICK | \$ 385.00 |
| SCFS-8 | 8" | CARBIDE TIPPED FLAT ROOT SAW BLADE ONLY. 3/16" THICK | \$ 446.00 |
| SCFS-10 | 10" | CARBIDE TIPPED FLAT ROOT SAW BLADE ONLY. 3/16" THICK | \$ 534.00 |
| SCFS-12 | 12" | CARBIDE TIPPED FLAT ROOT SAW BLADE ONLY. 3/16" THICK | \$ 653.00 |
| SCFS-15 | 15" | CARBIDE TIPPED FLAT ROOT SAW BLADE ONLY. 3/16" THICK | \$ 846.00 |



CARBIDE TIPPED AND WRAPPED CONCAVE ROOT SAWS

| | | | |
|----------------|------------|-----------------------------------------------------|------------------|
| SCS-6W | 6" | CARBIDE TIPPED AND CARBIDE WRAPPED CONCAVE ROOT SAW | \$ 463.00 |
| SCS-8W | 8" | CARBIDE TIPPED AND CARBIDE WRAPPED CONCAVE ROOT SAW | \$ 593.00 |
| SCS-10W | 10" | CARBIDE TIPPED AND CARBIDE WRAPPED CONCAVE ROOT SAW | \$ 703.00 |
| SCS-12W | 12" | CARBIDE TIPPED AND CARBIDE WRAPPED CONCAVE ROOT SAW | \$ 795.00 |
| SCS-15W | 15" | CARBIDE TIPPED AND CARBIDE WRAPPED CONCAVE ROOT SAW | \$ 938.00 |



CARBIDE TIPPED WRAPPED FLAT ROOT SAWS

| | | | |
|-----------------|------------|--------------------------------------------------|------------------|
| SCFS-6W | 6" | CARBIDE TIPPED AND CARBIDE WRAPPED FLAT ROOT SAW | \$ 433.00 |
| SCFS-8W | 8" | CARBIDE TIPPED AND CARBIDE WRAPPED FLAT ROOT SAW | \$ 543.00 |
| SCFS-10W | 10" | CARBIDE TIPPED AND CARBIDE WRAPPED FLAT ROOT SAW | \$ 644.00 |
| SCFS-12W | 12" | CARBIDE TIPPED AND CARBIDE WRAPPED FLAT ROOT SAW | \$ 729.00 |
| SCFS-15W | 15" | CARBIDE TIPPED AND CARBIDE WRAPPED FLAT ROOT SAW | \$ 859.00 |



ANY SAW IS AVAILABLE WITH A WELDED ON 1" ARBOR HUB FOR \$60.00 ADD "WH" TO PART NUMBER

SUPER DUTY LARGE DIAMETER CONCAVE ROOT SAWS WITH SPOKES AND 1" HUB

| | | | |
|----------------|------------|-----------------------------------------|------------------|
| SCRS-12 | 12" | CONCAVE HD SAW WITH 3 SPOKES AND 1" HUB | \$ 500.00 |
| SCRS-15 | 15" | CONCAVE HD SAW WITH 3 SPOKES AND 1" HUB | \$ 506.00 |
| SCRS-18 | 18" | CONCAVE HD SAW WITH 3 SPOKES AND 1" HUB | \$ 594.00 |
| SCRS-20 | 20" | CONCAVE HD SAW WITH 3 SPOKES AND 1" HUB | \$ 681.00 |
| SCRS-22 | 22" | CONCAVE HD SAW WITH 3 SPOKES AND 1" HUB | \$ 794.00 |
| SCRS-24 | 24" | CONCAVE HD SAW WITH 3 SPOKES AND 1" HUB | \$ 888.00 |



SUPER DUTY LARGE DIAMETER FLAT ROOT SAW WITH SPOKES AND 1" HUB

| | | | |
|----------------|------------|--------------------------------------|------------------|
| SFRS-12 | 12" | FLAT HD SAW WITH 3 SPOKES AND 1" HUB | \$ 500.00 |
| SFRS-15 | 15" | FLAT HD SAW WITH 3 SPOKES AND 1" HUB | \$ 506.00 |
| SFRS-18 | 18" | FLAT HD SAW WITH 3 SPOKES AND 1" HUB | \$ 594.00 |
| SFRS-20 | 20" | FLAT HD SAW WITH 3 SPOKES AND 1" HUB | \$ 681.00 |
| SFRS-22 | 22" | FLAT HD SAW WITH 3 SPOKES AND 1" HUB | \$ 794.00 |
| SFRS-24 | 24" | FLAT HD SAW WITH 3 SPOKES AND 1" HUB | \$ 888.00 |



SUPER DUTY LARGE DIAMETER CARBIDE TIPPED ROOT SAWS WITH SPOKES AND 1" HUB

| | | | |
|------------------|------------|---------------------------------------------------------|--------------------|
| SCRS-12HD | 12" | CONCAVE HD SAW WITH 3 SPOKES AND 1" HUB, CARBIDE TIPPED | \$ 919.00 |
| SCRS-15HD | 15" | CONCAVE HD SAW WITH 3 SPOKES AND 1" HUB, CARBIDE TIPPED | \$ 950.00 |
| SCRS-18HD | 18" | CONCAVE HD SAW WITH 3 SPOKES AND 1" HUB, CARBIDE TIPPED | \$ 1,038.00 |
| SCRS-20HD | 20" | CONCAVE HD SAW WITH 3 SPOKES AND 1" HUB, CARBIDE TIPPED | \$ 1,094.00 |
| SCRS-22HD | 22" | CONCAVE HD SAW WITH 3 SPOKES AND 1" HUB, CARBIDE TIPPED | \$ 1,194.00 |
| SCRS-24HD | 24" | CONCAVE HD SAW WITH 3 SPOKES AND 1" HUB, CARBIDE TIPPED | \$ 1,313.00 |



SUPER DUTY LARGE DIAMETER SHAM STYLE SEGMENTED SAWS WITH SPOKES AND 1" HUB

| | | | |
|------------------|------------|------------------------------------------------------------|------------------|
| SH-SAW-12 | 12" | SHAM STYLE SEGMENTED SAW W/ SPOKES AND 1" WELDED HUB/SHAFT | \$ 585.00 |
| SH-SAW-15 | 15" | SHAM STYLE SEGMENTED SAW W/ SPOKES AND 1" WELDED HUB/SHAFT | \$ 624.00 |
| SH-SAW-18 | 18" | SHAM STYLE SEGMENTED SAW W/ SPOKES AND 1" WELDED HUB/SHAFT | \$ 683.00 |
| SH-SAW-20 | 20" | SHAM STYLE SEGMENTED SAW W/ SPOKES AND 1" WELDED HUB/SHAFT | \$ 767.00 |
| SH-SAW-22 | 22" | SHAM STYLE SEGMENTED SAW W/ SPOKES AND 1" WELDED HUB/SHAFT | \$ 837.00 |
| SH-SAW-24 | 24" | SHAM STYLE SEGMENTED SAW W/ SPOKES AND 1" WELDED HUB/SHAFT | \$ 923.00 |



NOZZLE EXTENSIONS 1" - 3/4" - 1/2"

| | | |
|----------------|--------------------------------------------------------------------|-----------------|
| SSE-1/2 | STRAIGHT STYLE LIGHTWEIGHT NOZZLE EXTENSION <u>1/2" X 13"</u> LONG | \$ 57.00 |
| SSE-3/4 | STRAIGHT STYLE LIGHTWEIGHT NOZZLE EXTENSION <u>3/4" X 13"</u> LONG | \$ 58.00 |
| SSE-1 | STRAIGHT STYLE LIGHTWEIGHT NOZZLE EXTENSION <u>1" X 13"</u> LONG | \$ 59.00 |



4-FINNED NOZZLE EXTENSIONS 1"

| | | |
|---------------|-----------------------------------------------|------------------|
| FE-41 | 4" <u>1" X 4"</u> 4 FINNED NOZZLE EXTENSION | \$ 83.00 |
| FE-61 | 6" <u>1" X 6"</u> 4 FINNED NOZZLE EXTENSION | \$ 85.00 |
| FE-81 | 8" <u>1" X 8"</u> 4 FINNED NOZZLE EXTENSION | \$ 87.00 |
| FE-101 | 10" <u>1" X 10"</u> 4 FINNED NOZZLE EXTENSION | \$ 108.00 |
| FE-121 | 12" <u>1" X 12"</u> 4 FINNED NOZZLE EXTENSION | \$ 145.00 |
| FE-151 | 15" <u>1" X 15"</u> 4 FINNED NOZZLE EXTENSION | \$ 158.00 |

4-FINNED NOZZLE EXTENSIONS 3/4"

| | | |
|----------------|-------------------------------------------------|------------------|
| FE-434 | 4" <u>3/4" X 4"</u> 4 FINNED NOZZLE EXTENSION | \$ 83.00 |
| FE-634 | 6" <u>3/4" X 6"</u> 4 FINNED NOZZLE EXTENSION | \$ 85.00 |
| FE-834 | 8" <u>3/4" X 8"</u> 4 FINNED NOZZLE EXTENSION | \$ 87.00 |
| FE-1034 | 10" <u>3/4" X 10"</u> 4 FINNED NOZZLE EXTENSION | \$ 108.00 |
| FE-1234 | 12" <u>3/4" X 12"</u> 4 FINNED NOZZLE EXTENSION | \$ 145.00 |

4-FINNED NOZZLE EXTENSIONS 1/2"

| | | |
|----------------|-------------------------------------------------|------------------|
| FE-412 | 4" <u>1/2" X 4"</u> 4 FINNED NOZZLE EXTENSION | \$ 82.00 |
| FE-612 | 6" <u>1/2" X 6"</u> 4 FINNED NOZZLE EXTENSION | \$ 84.00 |
| FE-812 | 8" <u>1/2" X 8"</u> 4 FINNED NOZZLE EXTENSION | \$ 86.00 |
| FE-1012 | 10" <u>1/2" X 10"</u> 4 FINNED NOZZLE EXTENSION | \$ 106.00 |
| FE-1212 | 12" <u>1/2" X 12"</u> 4 FINNED NOZZLE EXTENSION | \$ 119.00 |

6-FINNED HEAVY DUTY NOZZLE EXTENSIONS

| | | |
|-----------------|----------------------------------------------------------------|------------------|
| FE-61-6 | 6" <u>1" X 6"</u> 6 FINNED, 3/16" THICK HEAVY DUTY EXTENSION | \$ 113.00 |
| FE-81-6 | 8" <u>1" X 8"</u> 6 FINNED, 3/16" THICK HEAVY DUTY EXTENSION | \$ 120.00 |
| FE-101-6 | 10" <u>1" X 10"</u> 6 FINNED, 3/16" THICK HEAVY DUTY EXTENSION | \$ 149.00 |
| FE-121-6 | 12" <u>1" X 12"</u> 6 FINNED, 3/16" THICK HEAVY DUTY EXTENSION | \$ 158.00 |
| FE-151-6 | 15" <u>1" X 15"</u> 6 FINNED, 3/16" THICK HEAVY DUTY EXTENSION | \$ 215.00 |
| FE-181-6 | 18" <u>1" X 18"</u> 6 FINNED, 3/16" THICK HEAVY DUTY EXTENSION | \$ 238.00 |

6-WIRE NOZZLE EXTENSIONS 1"

| | | |
|----------------|---------------------------------------------|------------------|
| WNE-41 | 4" <u>1" X 4"</u> 6 WIRE NOZZLE EXTENSION | \$ 91.00 |
| WNE-61 | 6" <u>1" X 6"</u> 6 WIRE NOZZLE EXTENSION | \$ 95.00 |
| WNE-81 | 8" <u>1" X 8"</u> 6 WIRE NOZZLE EXTENSION | \$ 99.00 |
| WNE-101 | 10" <u>1" X 10"</u> 6 WIRE NOZZLE EXTENSION | \$ 121.00 |
| WNE-121 | 12" <u>1" X 12"</u> 6 WIRE NOZZLE EXTENSION | \$ 142.00 |
| WNE-151 | 15" <u>1" X 15"</u> 6 WIRE NOZZLE EXTENSION | \$ 160.00 |
| WNE-181 | 18" <u>1" X 18"</u> 6 WIRE NOZZLE EXTENSION | \$ 173.00 |
| WNE-201 | 20" <u>1" X 20"</u> 6 WIRE NOZZLE EXTENSION | \$ 195.00 |
| WNE-241 | 24" <u>1" X 24"</u> 6 WIRE NOZZLE EXTENSION | \$ 214.00 |

6-WIRE NOZZLE EXTENSIONS 3/4"

| | | |
|-----------------|-----------------------------------------------|------------------|
| WNE-434 | 4" <u>3/4" X 4"</u> 6 WIRE NOZZLE EXTENSION | \$ 86.00 |
| WNE-634 | 6" <u>3/4" X 6"</u> 6 WIRE NOZZLE EXTENSION | \$ 91.00 |
| WNE-834 | 8" <u>3/4" X 8"</u> 6 WIRE NOZZLE EXTENSION | \$ 97.00 |
| WNE-1034 | 10" <u>3/4" X 10"</u> 6 WIRE NOZZLE EXTENSION | \$ 112.00 |
| WNE-1234 | 12" <u>3/4" X 12"</u> 6 WIRE NOZZLE EXTENSION | \$ 134.00 |
| WNE-1534 | 15" <u>3/4" X 15"</u> 6 WIRE NOZZLE EXTENSION | \$ 164.00 |

6-WIRE NOZZLE EXTENSIONS 1/2"

| | | |
|----------------|---------------------------------------------|-----------------|
| WNE-412 | 4" <u>1/2" X 4"</u> 6 WIRE NOZZLE EXTENSION | \$ 91.00 |
| WNE-612 | 6" <u>1/2" X 6"</u> 6 WIRE NOZZLE EXTENSION | \$ 91.00 |

4-WIRE NOZZLE EXTENSIONS 1"

| | | |
|--------------|---------------------------------------------|------------------|
| W4-1 | 4" <u>1" X 4"</u> 4 WIRE NOZZLE EXTENSION | \$ 78.00 |
| W6-1 | 6" <u>1" X 6"</u> 4 WIRE NOZZLE EXTENSION | \$ 82.00 |
| W8-1 | 8" <u>1" X 8"</u> 4 WIRE NOZZLE EXTENSION | \$ 86.00 |
| W10-1 | 10" <u>1" X 10"</u> 4 WIRE NOZZLE EXTENSION | \$ 94.00 |
| W12-1 | 12" <u>1" X 12"</u> 4 WIRE NOZZLE EXTENSION | \$ 102.00 |

4-WIRE NOZZLE EXTENSIONS 3/4"

| | | |
|---------------|-----------------------------------------------|------------------|
| W4-34 | 4" <u>3/4" X 4"</u> 4 WIRE NOZZLE EXTENSION | \$ 78.00 |
| W6-34 | 6" <u>3/4" X 6"</u> 4 WIRE NOZZLE EXTENSION | \$ 82.00 |
| W8-34 | 8" <u>3/4" X 8"</u> 4 WIRE NOZZLE EXTENSION | \$ 86.00 |
| W10-34 | 10" <u>3/4" X 10"</u> 4 WIRE NOZZLE EXTENSION | \$ 94.00 |
| W12-34 | 12" <u>3/4" X 12"</u> 4 WIRE NOZZLE EXTENSION | \$ 102.00 |

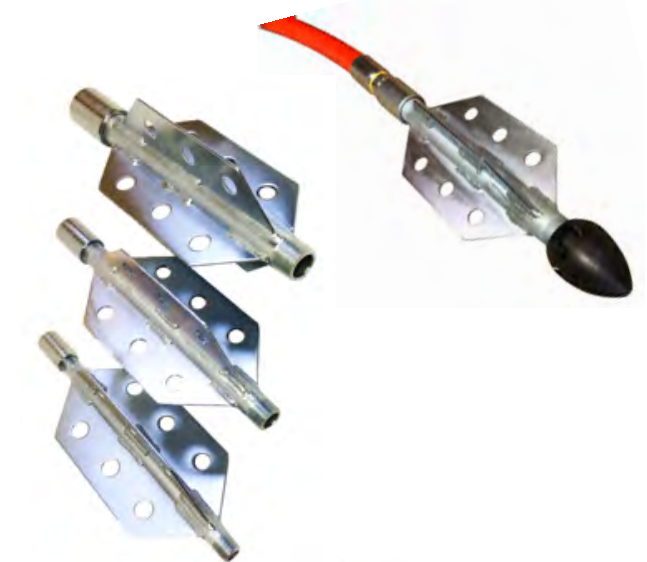

3/8" THICK RAILS

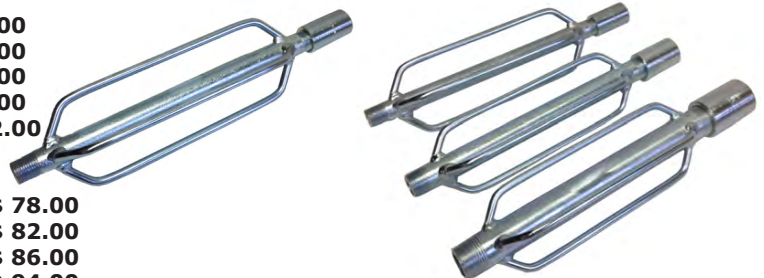

4-WIRE NOZZLE EXTENSIONS 1/2"

| | | | | |
|--------|-----|------------|-------------------------|----------|
| W4-12 | 4" | 1/2" X 4" | 4 WIRE NOZZLE EXTENSION | \$ 78.00 |
| W6-12 | 6" | 1/2" X 6" | 4 WIRE NOZZLE EXTENSION | \$ 82.00 |
| W8-12 | 8" | 1/2" X 8" | 4 WIRE NOZZLE EXTENSION | \$ 86.00 |
| W10-12 | 10" | 1/2" X 10" | 4 WIRE NOZZLE EXTENSION | \$ 90.00 |

FOOTBALL STYLE NOZZLE EXTENSIONS 1"

| | | | | |
|---------|-----|----------|---------------------------|-----------|
| NFL-41 | 4" | 1" X 4" | FOOTBALL NOZZLE EXTENSION | \$ 80.00 |
| NFL-61 | 6" | 1" X 6" | FOOTBALL NOZZLE EXTENSION | \$ 86.00 |
| NFL-81 | 8" | 1" X 8" | FOOTBALL NOZZLE EXTENSION | \$ 91.00 |
| NFL-101 | 10" | 1" X 10" | FOOTBALL NOZZLE EXTENSION | \$ 96.00 |
| NFL-121 | 12" | 1" X 12" | FOOTBALL NOZZLE EXTENSION | \$ 104.00 |
| NFL-151 | 15" | 1" X 15" | FOOTBALL NOZZLE EXTENSION | \$ 134.00 |

FOOTBALL STYLE NOZZLE EXTENSIONS 3/4"

| | | | | |
|----------|-----|------------|---------------------------|-----------|
| NFL-434 | 4" | 3/4" X 4" | FOOTBALL NOZZLE EXTENSION | \$ 78.00 |
| NFL-634 | 6" | 3/4" X 6" | FOOTBALL NOZZLE EXTENSION | \$ 85.00 |
| NFL-834 | 8" | 3/4" X 8" | FOOTBALL NOZZLE EXTENSION | \$ 90.00 |
| NFL-1034 | 10" | 3/4" X 10" | FOOTBALL NOZZLE EXTENSION | \$ 95.00 |
| NFL-1234 | 12" | 3/4" X 12" | FOOTBALL NOZZLE EXTENSION | \$ 102.00 |

FOOTBALL STYLE NOZZLE EXTENSIONS 1/2"

| | | | | |
|----------|-----|------------|---------------------------|----------|
| NFL-412 | 4" | 1/2" X 4" | FOOTBALL NOZZLE EXTENSION | \$ 77.00 |
| NFL-612 | 6" | 1/2" X 6" | FOOTBALL NOZZLE EXTENSION | \$ 84.00 |
| NFL-812 | 8" | 1/2" X 8" | FOOTBALL NOZZLE EXTENSION | \$ 90.00 |
| NFL-1012 | 10" | 1/2" X 10" | FOOTBALL NOZZLE EXTENSION | \$ 95.00 |

SUPER SHORT 8" FOOTBALL STYLE NOZZLE EXTENSIONS FOR 1" HOSE

ALSO AVAILABLE FOR 3/4" HOSE

| | | | |
|----------|----|-----------------------------------|-----------|
| NFL-41SS | 4" | FOOTBALL NOZZLE EXTENSION 8" LONG | \$ 88.00 |
| NFL-61SS | 6" | FOOTBALL NOZZLE EXTENSION 8" LONG | \$ 101.00 |
| NFL-81SS | 8" | FOOTBALL NOZZLE EXTENSION 8" LONG | \$ 115.00 |

NOZZLE EXTENSION WITH WHEELS 1"

| | | | |
|--------|-----|--------------------------------------------|-----------|
| WE-61 | 6" | 1" WHEELED NOZZLE EXTENSION FOR 6" AND UP | \$ 101.00 |
| WE-81 | 8" | 1" WHEELED NOZZLE EXTENSION FOR 8" AND UP | \$ 108.00 |
| WE-101 | 10" | 1" WHEELED NOZZLE EXTENSION FOR 10" AND UP | \$ 125.00 |
| WE-121 | 12" | 1" WHEELED NOZZLE EXTENSION FOR 12" AND UP | \$ 135.00 |
| WE-151 | 15" | 1" WHEELED NOZZLE EXTENSION FOR 15" AND UP | \$ 158.00 |

NOZZLE EXTENSION WITH WHEELS 3/4"

| | | | |
|---------|-----|---------------------------------------------|-----------|
| WE-634 | 6" | 3/4" WHEELED NOZZLE EXTENSION FOR 6" AND UP | \$ 101.00 |
| WE-834 | 8" | 3/4" WHEELED NOZZLE EXTENSION FOR 8" AND UP | \$ 108.00 |
| WE-1034 | 10" | 3/4" WHEELED NOZZLE EXTENSION FOR 8" AND UP | \$ 125.00 |
| WE-1234 | 12" | 3/4" WHEELED NOZZLE EXTENSION FOR 8" AND UP | \$ 135.00 |
| WE-1534 | 15" | 3/4" WHEELED NOZZLE EXTENSION FOR 8" AND UP | \$ 158.00 |

HEAVY DUTY TUBE STYLE EXTENSION (12" LONG)

| | | |
|---------|---------------------------------------------|-----------|
| TSE-1/2 | HEAVY DUTY TUBE STYLE NOZZLE EXTENSION 1/2" | \$ 181.00 |
| TSE-3/4 | HEAVY DUTY TUBE STYLE NOZZLE EXTENSION 3/4" | \$ 195.00 |
| TSE-1 | HEAVY DUTY TUBE STYLE NOZZLE EXTENSION 1" | \$ 217.00 |

SUPER SHORT 10 LEG PROOFERS (WELDED/NON REPLACEABLE)

ALL PROOFERS ARE 1/2" UNDER SIZE

| | | |
|------|--------------------------------------------------|-----------|
| S-6 | 6" SHORT PROOFER <u>6" O.D X 1"</u> (14" LONG) | \$ 296.00 |
| S-8 | 8" SHORT PROOFER <u>8" O.D X 1"</u> (14" LONG) | \$ 307.00 |
| S-10 | 10" SHORT PROOFER <u>10" O.D X 1"</u> (17" LONG) | \$ 326.00 |
| S-12 | 12" SHORT PROOFER <u>12" O.D X 1"</u> (17" LONG) | \$ 338.00 |
| S-15 | 15" SHORT PROOFER <u>15" O.D X 1"</u> (19" LONG) | \$ 349.00 |
| S-18 | 18" SHORT PROOFER <u>18" O.D X 1"</u> (23" LONG) | \$ 367.00 |
| S-20 | 20" SHORT PROOFER <u>20" O.D X 1"</u> (24" LONG) | \$ 378.00 |
| S-24 | 24" SHORT PROOFER <u>24" O.D X 1"</u> (28" LONG) | \$ 402.00 |

LONG 10 LEG PROOFERS (REMOVABLE/REPLACEABLE)

ALL PROOFERS ARE 1/2" UNDER SIZE

| | | |
|------|-------------------------------------------------|-----------|
| L-6 | 6" LONG PROOFER <u>6" O.D X 1"</u> (14" LONG) | \$ 348.00 |
| L-8 | 8" LONG PROOFER <u>8" O.D X 1"</u> (17" LONG) | \$ 354.00 |
| L-10 | 10" LONG PROOFER <u>10" O.D X 1"</u> (20" LONG) | \$ 373.00 |
| L-12 | 12" LONG PROOFER <u>12" O.D X 1"</u> (20" LONG) | \$ 378.00 |
| L-15 | 15" LONG PROOFER <u>15" O.D X 1"</u> (23" LONG) | \$ 432.00 |
| L-18 | 18" LONG PROOFER <u>18" O.D X 1"</u> (26" LONG) | \$ 456.00 |
| L-20 | 20" LONG PROOFER <u>20" O.D X 1"</u> (28" LONG) | \$ 467.00 |
| L-24 | 24" LONG PROOFER <u>24" O.D X 1"</u> (31" LONG) | \$ 473.00 |

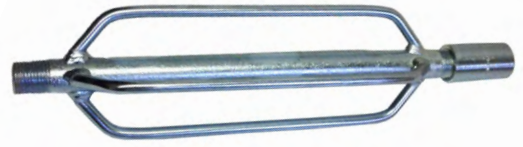

3/8" THICK RAILS



SECTIONAL AND CONTINUOUS ROD, TOOLS AND ACCESSORIES

ADAPTER RODS

| | | | |
|----------|-------|-----------------------|----------|
| AR-1-1 | 5/16" | ADAPTER ROD (8" Long) | \$ 10.00 |
| AR-1-2 | 3/8" | ADAPTER ROD (8" Long) | \$ 13.00 |
| AR-1-SS | 5/16" | SUPER SHORT (4" Long) | \$ 10.00 |
| AR-1-2SS | 3/8" | SUPER SHORT (4" Long) | \$ 13.00 |



PREMIUM PUMA RODS

| | | | |
|----------|-------------|------------------------------------------|----------|
| STR-1-1 | 5/16" X 36" | PREMIUM SEWER ROD COMPLETE WITH COUPLING | \$ 17.00 |
| STR-1-2 | 5/16" X 39" | PREMIUM SEWER ROD COMPLETE WITH COUPLING | \$ 18.00 |
| STR-1-3 | 5/16" X 48" | PREMIUM SEWER ROD COMPLETE WITH COUPLING | \$ 19.00 |
| STR-1-4 | 5/16" X 60" | PREMIUM SEWER ROD COMPLETE WITH COUPLING | \$ 20.00 |
| STR-1-5 | 5/16" X 72" | PREMIUM SEWER ROD COMPLETE WITH COUPLING | \$ 24.00 |
| STR-1-6 | 3/8" X 36" | PREMIUM SEWER ROD COMPLETE WITH COUPLING | \$ 23.00 |
| STR-1-7 | 3/8" X 39" | PREMIUM SEWER ROD COMPLETE WITH COUPLING | \$ 25.00 |
| STR-1-8 | 3/8" X 48" | PREMIUM SEWER ROD COMPLETE WITH COUPLING | \$ 27.00 |
| STR-1-9 | 3/8" X 60" | PREMIUM SEWER ROD COMPLETE WITH COUPLING | \$ 29.00 |
| STR-1-10 | 3/8" X 72" | PREMIUM SEWER ROD COMPLETE WITH COUPLING | \$ 33.00 |



PUMA SILVER RODS



| | | | |
|----------|-------------|----------------------------------|----------|
| STB-1-1 | 5/16" X 36" | SEWER ROD COMPLETE WITH COUPLING | \$ 16.00 |
| STB-1-2 | 5/16" X 39" | SEWER ROD COMPLETE WITH COUPLING | \$ 17.00 |
| STB-1-3 | 5/16" X 48" | SEWER ROD COMPLETE WITH COUPLING | \$ 18.00 |
| STB-1-4 | 5/16" X 60" | SEWER ROD COMPLETE WITH COUPLING | \$ 20.00 |
| STB-1-5 | 5/16" X 72" | SEWER ROD COMPLETE WITH COUPLING | \$ 23.00 |
| STB-1-6 | 3/8" X 36" | SEWER ROD COMPLETE WITH COUPLING | \$ 20.00 |
| STB-1-7 | 3/8" X 39" | SEWER ROD COMPLETE WITH COUPLING | \$ 23.00 |
| STB-1-8 | 3/8" X 48" | SEWER ROD COMPLETE WITH COUPLING | \$ 24.00 |
| STB-1-9 | 3/8" X 60" | SEWER ROD COMPLETE WITH COUPLING | \$ 27.00 |
| STB-1-10 | 3/8" X 72" | SEWER ROD COMPLETE WITH COUPLING | \$ 31.00 |



QUICK COUPLE RODS

ALL 5/16" RODS ARE AVAILABLE WITH QUICK CONNECT DISCONNECT SPRING LOADED PIN COUPLINGS. PLEASE ADD "R" TO PART NUMBER AND ADD \$14.00 TO EACH ROD OR TOOL
3/8" RODS NOT AVAILABLE WITH QUICK CONNECT!!

| | | |
|-------|---------------------------------------------------|----------|
| PIN-1 | QUICK DISCONNECT TOOL FOR ABOVE QUICK COUPLE RODS | \$ 21.00 |
|-------|---------------------------------------------------|----------|



ROD TOOLS

PICK UP TOOLS

| | | | |
|------|-------|---------------------------------|----------|
| P1-1 | 5/16" | PICK UP TOOL FOR SECTIONAL ROD | \$ 34.00 |
| P1-2 | 3/8" | PICK UP TOOL FOR SECTIONAL ROD | \$ 41.00 |
| P1-3 | 3/8" | PICK UP TOOL FOR CONTINUOUS ROD | \$ 53.00 |



SPEAR HEADS

| | | |
|------|---------------------------------------------------|----------|
| B2-1 | 2" SPEAR HEAD WITH 5/16" ADAPTER ROD AND COUPLING | \$ 35.00 |
| B2-2 | 2" SPEAR HEAD WITH 3/8" ADAPTER ROD AND COUPLING | \$ 44.00 |
| B4-1 | 4" SPEAR HEAD WITH 5/16" ADAPTER ROD AND COUPLING | \$ 61.00 |
| B4-2 | 4" SPEAR HEAD WITH 3/8" ADAPTER ROD AND COUPLING | \$ 66.00 |

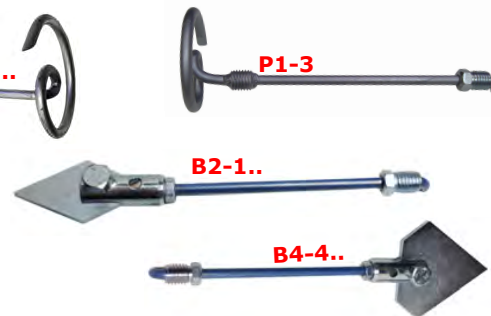

ASSEMBLY TOOLS

| | | | |
|------|-------|-----------------|----------|
| T1-1 | 5/16" | ASSEMBLY WRENCH | \$ 36.00 |
| T1-2 | 3/8" | ASSEMBLY WRENCH | \$ 37.00 |



| | | | |
|------|-------|-------------------------|----------|
| T2-1 | 5/16" | ASSEMBLY TURNING HANDLE | \$ 70.00 |
| T2-2 | 3/8" | ASSEMBLY TURNING HANDLE | \$ 74.00 |



PULL OUT AND TURNING TOOLS

| | | | |
|------|-------|---------------|----------|
| T3-1 | 5/16" | PULL OUT TOOL | \$ 43.00 |
| T3-2 | 3/8" | PULL OUT TOOL | \$ 44.00 |



| | | | |
|------|-------|------------------------------------------|----------|
| T4-1 | 5/16" | PULL OUT & TWISTING HANDLE | \$ 49.00 |
| T4-2 | 3/8" | PULL OUT & TWISTING HANDLE | \$ 49.00 |
| T4-R | | QUICK CONNECT PULL OUT & TWISTING HANDLE | \$ 66.00 |



| | | |
|------|---------------------------------------|----------|
| T5-1 | BAR TURNING HANDLE FOR 5/16" AND 3/8" | \$ 25.00 |
|------|---------------------------------------|----------|



ROD TOOLS

| | | | |
|-----|--------------------|--------------------------------------------|-----------|
| T8 | <u>1/4" - 3/8"</u> | ROUND ROD PULL-OUT FITS TOOLS 1/4" TO 3/8" | \$ 193.00 |
| T11 | <u>5/16"</u> | ROD TURNING RATCHET SINGLE FOR 5/16" RODS | \$ 205.00 |
| T12 | <u>5/16"</u> | ROD TURNING RATCHET ONE MAN DOUBLE | \$ 284.00 |
| T13 | <u>3/8"</u> | ROD TURNING RATCHET SINGLE FOR 3/8" RODS | \$ 215.00 |
| T14 | <u>3/8"</u> | ROD TURNING RATCHET ONE MAN DOUBLE | \$ 309.00 |



SPECIAL BORING TOOLS

| | | | |
|-------|--------------|--------------------------------------------------------|-----------|
| T6-1 | <u>5/16"</u> | LOOP SWIVEL TOOL | \$ 39.00 |
| T6-2 | <u>3/8"</u> | LOOP SWIVEL TOOL | \$ 49.00 |
| T7-1 | <u>5/16"</u> | SAND LEADER T7-2 & COUPLING | \$ 45.00 |
| T7-2 | <u>3/8"</u> | SAND LEADER WITH ADAPTER ROD & COUPLING | \$ 48.00 |
| T9-1 | <u>5/16"</u> | BULLET TOOL WITH ADAPTER ROD | \$ 30.00 |
| T9-2 | <u>3/8"</u> | BULLET TOOL WITH ADAPTER ROD | \$ 41.00 |
| T10-1 | <u>5/16"</u> | PILOT BULLET TOOL WITH PULLOUT SWIVEL WITH ADAPTER ROD | \$ 131.00 |
| T10-2 | <u>3/8"</u> | PILOT BULLET TOOL WITH PULLOUT SWIVEL WITH ADAPTER ROD | \$ 142.00 |
| T15-1 | <u>5/16"</u> | "WINTERS" ROOT SAW COUPLING. COMBINE ANY 2 ROOT SAW | \$ 137.00 |
| T15-2 | <u>3/8"</u> | "WINTERS" ROOT SAW COUPLING. COMBINE ANY 2 ROOT SAW | \$ 145.00 |



CONTINUOUS ROD TOOLS SEE NOTE:

Set Screw Ends: For Set Screw Coupling Add "SS" and Either 3 for .375, 4 for .393, 5 for .415 or 6 for .461 rod.
Direct Hook Ends: For Direct Hook End Add "DH" and Either 3 for .375, 4 for .393, 5 for .415 or 6 for .461 rod..

CLEANING TOOLS

ROUND WIRE CORKSCREWS

| | | | |
|------|---------------|----------------------------|----------|
| F1-1 | <u>1-1/2"</u> | USE WITH 5/16" ROD | \$ 32.00 |
| F1-2 | <u>1-1/2"</u> | USE WITH 3/8" ROD | \$ 45.00 |
| F2-1 | <u>2"</u> | USE WITH 5/16" ROD | \$ 32.00 |
| F2-2 | <u>2"</u> | USE WITH 3/8" ROD | \$ 45.00 |
| F3-1 | <u>3"</u> | USE WITH 5/16" ROD | \$ 32.00 |
| F3-2 | <u>3"</u> | USE WITH 3/8" ROD | \$ 45.00 |
| F4-1 | <u>3-1/2"</u> | USE WITH 5/16" ROD | \$ 32.00 |
| F4-2 | <u>3-1/2"</u> | USE WITH 3/8" ROD | \$ 45.00 |
| F5-1 | <u>5"</u> | USE WITH 5/16" ADAPTER ROD | \$ 32.00 |
| F5-2 | <u>5"</u> | USE WITH 3/8" ROD | \$ 45.00 |
| F6-1 | <u>6"</u> | USE WITH 5/16" ADAPTER ROD | \$ 48.00 |
| F6-2 | <u>6"</u> | USE WITH 3/8" ROD | \$ 53.00 |



DOUBLE ROUND WIRE CORKSCREWS

| | | | |
|-------|-----------|--------------------|-----------|
| FD3-1 | <u>3"</u> | USE WITH 5/16" ROD | \$ 126.00 |
| FD3-2 | <u>3"</u> | USE WITH 3/8" ROD | \$ 135.00 |
| FD4-1 | <u>4"</u> | USE WITH 5/16" ROD | \$ 133.00 |
| FD4-2 | <u>4"</u> | USE WITH 3/8" ROD | \$ 151.00 |
| FD6-1 | <u>6"</u> | USE WITH 5/16" ROD | \$ 154.00 |
| FD6-2 | <u>6"</u> | USE WITH 3/8" ROD | \$ 166.00 |



SAND CORKSCREWS

| | | | |
|-------|-----------|-----------------------------------|----------|
| G-3-1 | <u>3"</u> | SAND CORKSCREW USE WITH 5/16" ROD | \$ 75.00 |
| G-3-2 | <u>3"</u> | SAND CORKSCREW USE WITH 3/8" ROD | \$ 86.00 |



NOTE: For any cleaning tool you can buy the tool only less the coupling and adapter rod by adding a "B" after the part number

AUGERS

| | | |
|-------|-------------------------|-----------|
| A2-1 | 2" AUGER FOR 5/16" ROD | \$ 78.00 |
| A2-2 | 2" AUGER FOR 3/8" ROD | \$ 87.00 |
| A3-1 | 3" AUGER FOR 5/16" ROD | \$ 80.00 |
| A3-2 | 3" AUGER FOR 3/8" ROD | \$ 88.00 |
| A4-1 | 4" AUGER FOR 5/16" ROD | \$ 103.00 |
| A4-2 | 4" AUGER FOR 3/8" ROD | \$ 106.00 |
| A5-1 | 5" AUGER FOR 5/16" ROD | \$ 142.00 |
| A5-2 | 5" AUGER FOR 3/8" ROD | \$ 151.00 |
| A6-1 | 6" AUGER FOR 5/16" ROD | \$ 188.00 |
| A6-2 | 6" AUGER FOR 3/8" ROD | \$ 195.00 |
| A8-1 | 8" AUGER FOR 5/16" ROD | \$ 242.00 |
| A8-2 | 8" AUGER FOR 3/8" ROD | \$ 253.00 |
| A10-1 | 10" AUGER FOR 5/16" ROD | \$ 301.00 |
| A10-2 | 10" AUGER FOR 3/8" ROD | \$ 312.00 |



Set Screw Ends: For Set Screw Coupling Add "SS" and Either 3 for .375, 4 for .393, 5 for .415 or 6 for .461 rod.
Direct Hook Ends: For Direct Hook End Add "DH" and Either 3 for .375, 4 for .393, 5 for .415 or 6 for .461 rod.

SQUARE BAR CORKSCREWS

| | | |
|-------|----------------------------------------|-----------|
| E2-1 | 2" SQUARE BAR CORKSCREW FOR 5/16" ROD | \$ 149.00 |
| E2-2 | 2" SQUARE BAR CORKSCREW FOR 3/8" ROD | \$ 158.00 |
| E3-1 | 3" SQUARE BAR CORKSCREW FOR 5/16" ROD | \$ 156.00 |
| E3-2 | 3" SQUARE BAR CORKSCREW FOR 3/8" ROD | \$ 158.00 |
| E4-1 | 4" SQUARE BAR CORKSCREW FOR 5/16" ROD | \$ 161.00 |
| E4-2 | 4" SQUARE BAR CORKSCREW FOR 3/8" ROD | \$ 173.00 |
| E5-1 | 5" SQUARE BAR CORKSCREW FOR 5/16" ROD | \$ 171.00 |
| E5-2 | 5" SQUARE BAR CORKSCREW FOR 3/8" ROD | \$ 180.00 |
| E6-1 | 6" SQUARE BAR CORKSCREW FOR 5/16" ROD | \$ 194.00 |
| E6-2 | 6" SQUARE BAR CORKSCREW FOR 3/8" ROD | \$ 204.00 |
| E8-1 | 8" SQUARE BAR CORKSCREW FOR 5/16" ROD | \$ 207.00 |
| E8-2 | 8" SQUARE BAR CORKSCREW FOR 3/8" ROD | \$ 237.00 |
| E8-4 | 8" HD SQUARE BAR CORKSCREW FOR 5/16" | \$ 290.00 |
| E8-5 | 8" HD SQUARE BAR CORKSCREW FOR 3/8" | \$ 298.00 |
| E10-1 | 10" SQUARE BAR CORKSCREW FOR 5/16" ROD | \$ 333.00 |
| E10-2 | 10" SQUARE BAR CORKSCREW FOR 3/8" ROD | \$ 344.00 |
| E12-1 | 12" SQUARE BAR CORKSCREW FOR 5/16" ROD | \$ 387.00 |
| E12-2 | 12" SQUARE BAR CORKSCREW FOR 3/8" ROD | \$ 403.00 |



Set Screw Ends: For Set Screw Coupling Add "SS" and Either 3 for .375, 4 for .393, 5 for .415 or 6 for .461 rod.
Direct Hook Ends: For Direct Hook End Add "DH" and Either 3 for .375, 4 for .393, 5 for .415 or 6 for .461 rod.

ROOT SAWS

STANDARD DUTY CONCAVE ROOT SAW

| | | |
|----------|------------------------------------|-----------|
| CRS-3-1 | 3" CONCAVE ROOT SAW FOR 5/16" ROD | \$ 142.00 |
| CRS-3-2 | 3" CONCAVE ROOT SAW FOR 3/8" ROD | \$ 151.00 |
| CRS-4-1 | 4" CONCAVE ROOT SAW FOR 5/16" ROD | \$ 156.00 |
| CRS-4-2 | 4" CONCAVE ROOT SAW FOR 3/8" ROD | \$ 167.00 |
| CRS-5-1 | 5" CONCAVE ROOT SAW FOR 5/16" ROD | \$ 172.00 |
| CRS-5-2 | 5" CONCAVE ROOT SAW FOR 3/8" ROD | \$ 180.00 |
| CRS-6-1 | 6" CONCAVE ROOT SAW FOR 5/16" ROD | \$ 186.00 |
| CRS-6-2 | 6" CONCAVE ROOT SAW FOR 3/8" ROD | \$ 194.00 |
| CRS-8-1 | 8" CONCAVE ROOT SAW FOR 5/16" ROD | \$ 204.00 |
| CRS-8-2 | 8" CONCAVE ROOT SAW FOR 3/8" ROD | \$ 214.00 |
| CRS-10-1 | 10" CONCAVE ROOT SAW FOR 5/16" ROD | \$ 228.00 |
| CRS-10-2 | 10" CONCAVE ROOT SAW FOR 3/8" ROD | \$ 237.00 |
| CRS-12-1 | 12" CONCAVE ROOT SAW FOR 5/16" ROD | \$ 260.00 |
| CRS-12-2 | 12" CONCAVE ROOT SAW FOR 3/8" ROD | \$ 269.00 |
| CRS-15-1 | 15" CONCAVE ROOT SAW FOR 5/16" ROD | \$ 293.00 |
| CRS-15-2 | 15" CONCAVE ROOT SAW FOR 3/8" ROD | \$ 304.00 |



Set Screw Ends: For Set Screw Coupling Add "SS" and Either 3 for .375, 4 for .393, 5 for .415 or 6 for .461 rod.
Direct Hook Ends: For Direct Hook End Add "DH" and Either 3 for .375, 4 for .393, 5 for .415 or 6 for .461 rod.

NOTE: For any cleaning tool you can buy the tool only less the coupling and adapter rod by adding a "B" after the part number

STANDARD DUTY FLAT ROOT SAWS

| | | |
|----------|------------------------------------------|-----------|
| FRS-3-1 | 3" STANDARD FLAT ROOT SAW FOR 5/16" ROD | \$ 142.00 |
| FRS-3-2 | 3" STANDARD FLAT ROOT SAW FOR 3/8" ROD | \$ 151.00 |
| FRS-4-1 | 4" STANDARD FLAT ROOT SAW FOR 5/16" ROD | \$ 156.00 |
| FRS-4-2 | 4" STANDARD FLAT ROOT SAW FOR 3/8" ROD | \$ 167.00 |
| FRS-6-1 | 6" STANDARD FLAT ROOT SAW FOR 5/16" ROD | \$ 186.00 |
| FRS-6-2 | 6" STANDARD FLAT ROOT SAW FOR 3/8" ROD | \$ 194.00 |
| FRS-8-1 | 8" STANDARD FLAT ROOT SAW FOR 5/16" ROD | \$ 204.00 |
| FRS-8-2 | 8" STANDARD FLAT ROOT SAW FOR 3/8" ROD | \$ 214.00 |
| FRS-10-1 | 10" STANDARD FLAT ROOT SAW FOR 5/16" ROD | \$ 228.00 |
| FRS-10-2 | 10" STANDARD FLAT ROOT SAW FOR 3/8" ROD | \$ 237.00 |
| FRS-12-1 | 12" STANDARD FLAT ROOT SAW FOR 5/16" ROD | \$ 260.00 |
| FRS-12-2 | 12" STANDARD FLAT ROOT SAW FOR 3/8" ROD | \$ 269.00 |
| FRS-15-1 | 15" STANDARD FLAT ROOT SAW FOR 5/16" ROD | \$ 293.00 |
| FRS-15-2 | 15" STANDARD FLAT ROOT SAW FOR 3/8" ROD | \$ 304.00 |



Set Screw Ends: For Set Screw Coupling Add "SS" and Either 3 for .375, 4 for .393, 5 for .415 or 6 for .461 rod.
Direct Hook Ends: For Direct Hook End Add "DH" and Either 3 for .375, 4 for .393, 5 for .415 or 6 for .461 rod.

HEAVY DUTY CONCAVE ROOT SAWS

| | | |
|-----------|---------------------------------------|-----------|
| HCRS-3-1 | 3" HD CONCAVE ROOT SAW FOR 5/16" ROD | \$ 142.00 |
| HCRS-3-2 | 3" HD CONCAVE ROOT SAW FOR 3/8" ROD | \$ 151.00 |
| HCRS-4-1 | 4" HD CONCAVE ROOT SAW FOR 5/16" ROD | \$ 156.00 |
| HCRS-4-2 | 4" HD CONCAVE ROOT SAW FOR 3/8" ROD | \$ 167.00 |
| HCRS-5-1 | 5" HD CONCAVE ROOT SAW FOR 5/16" ROD | \$ 172.00 |
| HCRS-5-2 | 5" HD CONCAVE ROOT SAW FOR 3/8" ROD | \$ 180.00 |
| HCRS-6-1 | 6" HD CONCAVE ROOT SAW FOR 5/16" ROD | \$ 186.00 |
| HCRS-6-2 | 6" HD CONCAVE ROOT SAW FOR 3/8" ROD | \$ 194.00 |
| HCRS-8-1 | 8" HD CONCAVE ROOT SAW FOR 5/16" ROD | \$ 204.00 |
| HCRS-8-2 | 8" HD CONCAVE ROOT SAW FOR 3/8" ROD | \$ 214.00 |
| HCRS-10-1 | 10" HD CONCAVE ROOT SAW FOR 5/16" ROD | \$ 228.00 |
| HCRS-10-2 | 10" HD CONCAVE ROOT SAW FOR 3/8" ROD | \$ 237.00 |
| HCRS-12-1 | 12" HD CONCAVE ROOT SAW FOR 5/16" ROD | \$ 260.00 |
| HCRS-12-2 | 12" HD CONCAVE ROOT SAW FOR 3/8" ROD | \$ 269.00 |
| HCRS-15-1 | 15" HD CONCAVE ROOT SAW FOR 5/16" ROD | \$ 293.00 |
| HCRS-15-2 | 15" HD CONCAVE ROOT SAW FOR 3/8" ROD | \$ 304.00 |
| HCRS-18-1 | 18" HD CONCAVE ROOT SAW FOR 5/16" ROD | \$ 328.00 |
| HCRS-18-2 | 18" HD CONCAVE ROOT SAW FOR 3/8" ROD | \$ 339.00 |
| HCRS-20-1 | 20" HD CONCAVE ROOT SAW FOR 5/16" ROD | \$ 382.00 |
| HCRS-20-2 | 20" HD CONCAVE ROOT SAW FOR 3/8" ROD | \$ 393.00 |



Set Screw Ends: For Set Screw Coupling Add "SS" and Either 3 for .375, 4 for .393, 5 for .415 or 6 for .461 rod.
Direct Hook Ends: For Direct Hook End Add "DH" and Either 3 for .375, 4 for .393, 5 for .415 or 6 for .461 rod.

HEAVY DUTY FLAT ROOT SAWS

| | | |
|-----------|------------------------------------|-----------|
| HFRS-3-1 | 3" HD FLAT ROOT SAW FOR 5/16" ROD | \$ 142.00 |
| HFRS-3-2 | 3" HD FLAT ROOT SAW FOR 3/8" ROD | \$ 151.00 |
| HFRS-4-1 | 4" HD FLAT ROOT SAW FOR 5/16" ROD | \$ 156.00 |
| HFRS-4-2 | 4" HD FLAT ROOT SAW FOR 3/8" ROD | \$ 167.00 |
| HFRS-5-1 | 5" HD FLAT ROOT SAW FOR 5/16" ROD | \$ 172.00 |
| HFRS-5-2 | 5" HD FLAT ROOT SAW FOR 3/8" ROD | \$ 180.00 |
| HFRS-6-1 | 6" HD FLAT ROOT SAW FOR 5/16" ROD | \$ 186.00 |
| HFRS-6-2 | 6" HD FLAT ROOT SAW FOR 3/8" ROD | \$ 194.00 |
| HFRS-8-1 | 8" HD FLAT ROOT SAW FOR 5/16" ROD | \$ 204.00 |
| HFRS-8-2 | 8" HD FLAT ROOT SAW FOR 3/8" ROD | \$ 214.00 |
| HFRS-10-1 | 10" HD FLAT ROOT SAW FOR 5/16" ROD | \$ 228.00 |
| HFRS-10-2 | 10" HD FLAT ROOT SAW FOR 3/8" ROD | \$ 237.00 |
| HFRS-12-1 | 12" HD FLAT ROOT SAW FOR 5/16" ROD | \$ 260.00 |
| HFRS-12-2 | 12" HD FLAT ROOT SAW FOR 3/8" ROD | \$ 269.00 |
| HFRS-15-1 | 15" HD FLAT ROOT SAW FOR 5/16" ROD | \$ 293.00 |
| HFRS-15-2 | 15" HD FLAT ROOT SAW FOR 3/8" ROD | \$ 304.00 |
| HFRS-18-1 | 18" HD FLAT ROOT SAW FOR 5/16" ROD | \$ 328.00 |
| HFRS-18-2 | 18" HD FLAT ROOT SAW FOR 3/8" ROD | \$ 339.00 |
| HFRS-20-1 | 20" HD FLAT ROOT SAW FOR 5/16" ROD | \$ 382.00 |
| HFRS-20-2 | 20" HD FLAT ROOT SAW FOR 3/8" ROD | \$ 393.00 |



Set Screw Ends: For Set Screw Coupling Add "SS" and Either 3 for .375, 4 for .393, 5 for .415 or 6 for .461 rod.
Direct Hook Ends: For Direct Hook End Add "DH" and Either 3 for .375, 4 for .393, 5 for .415 or 6 for .461 rod.

ADDITIONAL CLEANING TOOLS

PORCUPINES

| | | |
|--------|---------------------------------------|-------------|
| D-4-1 | 4" PORCUPINE TURN TYPE FOR 5/16" ROD | \$ 290.00 |
| D-4-2 | 4" PORCUPINE TURN TYPE FOR 3/8" ROD | \$ 296.00 |
| D-6-1 | 6" PORCUPINE TURN TYPE FOR 5/16" ROD | \$ 439.00 |
| D-6-2 | 6" PORCUPINE TURN TYPE FOR 3/8" ROD | \$ 444.00 |
| D-8-1 | 8" PORCUPINE TURN TYPE FOR 5/16" ROD | \$ 575.00 |
| D-8-2 | 8" PORCUPINE TURN TYPE FOR 3/8" ROD | \$ 581.00 |
| D-10-1 | 10" PORCUPINE TURN TYPE FOR 5/16" ROD | \$ 629.00 |
| D-10-2 | 10" PORCUPINE TURN TYPE FOR 3/8" ROD | \$ 634.00 |
| D-12-1 | 12" PORCUPINE TURN TYPE FOR 5/16" ROD | \$ 726.00 |
| D-12-2 | 12" PORCUPINE TURN TYPE FOR 3/8" ROD | \$ 731.00 |
| D-15-1 | 15" PORCUPINE TURN TYPE FOR 5/16" ROD | \$ 955.00 |
| D-15-2 | 15" PORCUPINE TURN TYPE FOR 3/8" ROD | \$ 960.00 |
| D-18-1 | 18" PORCUPINE TURN TYPE FOR 5/16" ROD | \$ 1,247.00 |
| D-18-2 | 18" PORCUPINE TURN TYPE FOR 3/8" ROD | \$ 1,256.00 |

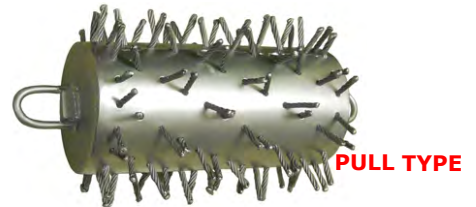
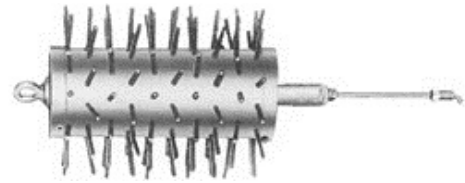

ALSO AVAILABLE IN PULL TYPE. PP-6, PP-8, PP-10 ETC... SAME PRICE

SEWER BRUSH FOR SWABBING / FINISHING LINE

| | | |
|--------|-------------------------------------|-----------|
| C-4-1 | 4" STEEL SEWER BRUSH FOR 5/16" ROD | \$ 156.00 |
| C-4-2 | 4" STEEL SEWER BRUSH FOR 3/8" ROD | \$ 167.00 |
| C-6-1 | 6" STEEL SEWER BRUSH FOR 5/16" ROD | \$ 161.00 |
| C-6-2 | 6" STEEL SEWER BRUSH FOR 3/8" ROD | \$ 177.00 |
| C-8-1 | 8" STEEL SEWER BRUSH FOR 5/16" ROD | \$ 172.00 |
| C-8-2 | 8" STEEL SEWER BRUSH FOR 3/8" ROD | \$ 188.00 |
| C-10-1 | 10" STEEL SEWER BRUSH FOR 5/16" ROD | \$ 215.00 |
| C-10-2 | 10" STEEL SEWER BRUSH FOR 3/8" ROD | \$ 231.00 |
| C-12-1 | 12" STEEL SEWER BRUSH FOR 5/16" ROD | \$ 290.00 |
| C-12-2 | 12" STEEL SEWER BRUSH FOR 3/8" ROD | \$ 306.00 |



3 BLADE CUTTERS CHUCKS

| | | | |
|--------|-------|---------------------------------|-----------|
| CH-1-1 | 5/16" | CHUCK WITH ADAPTER ROD | \$ 164.00 |
| CH-1-2 | 3/8" | CHUCK WITH ADAPTER ROD | \$ 164.00 |
| CH-1-3 | .375 | CHUCK WITH SET SCREW CONNECTION | \$ 164.00 |
| CH-1-4 | .393 | CHUCK WITH SET SCREW CONNECTION | \$ 172.00 |
| CH-1-5 | .415 | CHUCK WITH SET SCREW CONNECTION | \$ 172.00 |
| CH-1-6 | .461 | CHUCK WITH SET SCREW CONNECTION | \$ 172.00 |



SELECT CURVED BLADE FOR 3 BLADE CUTTER

| | | |
|-------|------------------------------------------------------------|----------|
| CB-4 | 4" CURVED BLADE FOR 3 BLADE CHUCK. PRICE <u>PER BLADE</u> | \$ 32.00 |
| CB-6 | 6" CURVED BLADE FOR 3 BLADE CHUCK. PRICE <u>PER BLADE</u> | \$ 34.00 |
| CB-8 | 8" CURVED BLADE FOR 3 BLADE CHUCK. PRICE <u>PER BLADE</u> | \$ 37.00 |
| CB-10 | 10" CURVED BLADE FOR 3 BLADE CHUCK. PRICE <u>PER BLADE</u> | \$ 40.00 |
| CB-12 | 12" CURVED BLADE FOR 3 BLADE CHUCK. PRICE <u>PER BLADE</u> | \$ 45.00 |
| CB-15 | 15" CURVED BLADE FOR 3 BLADE CHUCK. PRICE <u>PER BLADE</u> | \$ 47.00 |
| CB-18 | 18" CURVED BLADE FOR 3 BLADE CHUCK. PRICE <u>PER BLADE</u> | \$ 67.00 |

EACH BLADE



FOR FULL SIZE ADD "FS" AND \$2.00 TO EACH BLADE

SELECT FLAT BLADES FOR 3 BLADE CUTTER

| | | |
|-------|----------------------------------------------------------|----------|
| FB-4 | 4" FLAT BLADE FOR 3 BLADE CHUCK. PRICE <u>PER BLADE</u> | \$ 32.00 |
| FB-6 | 6" FLAT BLADE FOR 3 BLADE CHUCK. PRICE <u>PER BLADE</u> | \$ 34.00 |
| FB-8 | 8" FLAT BLADE FOR 3 BLADE CHUCK. PRICE <u>PER BLADE</u> | \$ 37.00 |
| FB-10 | 10" FLAT BLADE FOR 3 BLADE CHUCK. PRICE <u>PER BLADE</u> | \$ 40.00 |
| FB-12 | 12" FLAT BLADE FOR 3 BLADE CHUCK. PRICE <u>PER BLADE</u> | \$ 45.00 |
| FB-15 | 15" FLAT BLADE FOR 3 BLADE CHUCK. PRICE <u>PER BLADE</u> | \$ 47.00 |
| FB-18 | 18" FLAT BLADE FOR 3 BLADE CHUCK. PRICE <u>PER BLADE</u> | \$ 67.00 |

EACH BLADE



FOR FULL SIZE ADD "FS" AND \$2.00 TO EACH BLADE

POWER ROD DRIVE - TIER 2 PRODUCT

POWER DRIVES

| | | | |
|----------------|---------------|--------------------------------------------------------------|--------------------|
| SPD-3 | 3 HP | Power Drive Units Include Speed-Chuck, Specify 5/16" or 3/8" | \$ 3,833.00 |
| SPD-6.5 | 6.5 HP | Power Drive Units Include Speed-Chuck, Specify 5/16" or 3/8" | \$ 4,148.00 |
| SPD-8 | 8 HP | Power Drive Units Include Speed-Chuck, Specify 5/16" or 3/8" | \$ 4,883.00 |



price increase for 2024 - engines/motors increased in price

TRAILER AND ACCESSORIES

RR-1-1 Rod reel. Made from 1/2" round bar. 500' capacity. Can be used with either the tripod steel stand or trailer type **\$ 404.00**

RR-1-2 Rod reel stand street type. Guide tube with articulated elbow. 3 legs support the reel at perfect angle for pay-out **\$ 353.00**

RR-1-3 Rod reel stand trailer type. Same guide tube but the mounting plate to attach to trailer. Also can be modified to fit your truck **\$ 353.00**

RR-1-4 Lower manhole rigid rod guide. Connects to 1.5" pipe to allow the rods to enter the sewer at the correct angle **\$ 318.00**

RR-1-5 Foot jack support. Keeps pressure in the guide system by supporting the guide against back wall of manhole **\$ 160.00**

RR-1-6 Back jack support. Keeps pressure in the guide system by supporting the guide against back wall of manhole **\$ 173.00**

RR-1-7 Manhole jack support. Used to support the 1.5" guide tube against the manhole ring **\$ 226.00**

RR-1-8 Complete manhole set-up kit with 21' of galvanized. Comes with 21' of pipe in sections and RR1-4, RR1-5, RR1-6, and RR1-7 **\$ 1,019.00**

H-10-1 Carry all trailer. Can carry all your tools, rods and powerdrive to the job site. Includes a lockable and an open tool box. Comes with a standard 2" ball hitch and swivel 3rd wheel **\$ 5,093.00**

H-11-1 Stop, tail & turning lights **\$ 494.00**

H-12-1 Pintle ring hitch **\$ 147.00**

H-13-1 Electric brakes **\$ 1,129.00**

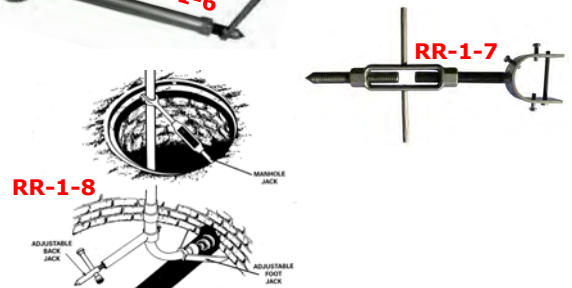
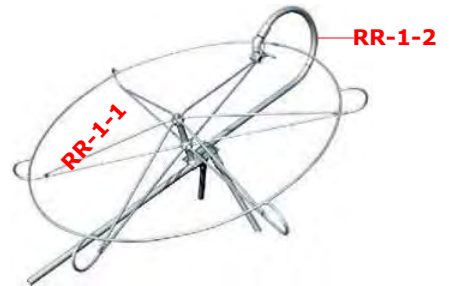

CONTINUOUS ROD AND RODDER

ACCESSORIES CONTINUOUS ROD GUIDE HOSES

| | | | |
|--------------|------------|-------------------------------------------------|--------------------|
| LW-7 | 7' | Lightweight Hose Guide With Flex-Metallic Liner | \$ 693.00 |
| LW-10 | 10' | Lightweight Hose Guide With Flex-Metallic Liner | \$ 814.00 |
| LW-15 | 15' | Lightweight Hose Guide With Flex-Metallic Liner | \$ 903.00 |
| LW-18 | 18' | Lightweight Hose Guide With Flex-Metallic Liner | \$ 942.00 |
| LW-20 | 20' | Lightweight Hose Guide With Flex-Metallic Liner | \$ 1,124.00 |
| LW-22 | 22' | Lightweight Hose Guide With Flex-Metallic Liner | \$ 1,208.00 |
| LW-24 | 24' | Lightweight Hose Guide With Flex-Metallic Liner | \$ 1,260.00 |
| LW-25 | 25' | Lightweight Hose Guide With Flex-Metallic Liner | \$ 1,271.00 |



| | | | |
|--------------|------------|-------------------------------------------|--------------------|
| HD-7 | 7' | Heavy Duty Hose Guide With Metallic Liner | \$ 709.00 |
| HD-10 | 10' | Heavy Duty Hose Guide With Metallic Liner | \$ 893.00 |
| HD-15 | 15' | Heavy Duty Hose Guide With Metallic Liner | \$ 1,076.00 |
| HD-18 | 18' | Heavy Duty Hose Guide With Metallic Liner | \$ 1,129.00 |
| HD-20 | 20' | Heavy Duty Hose Guide With Metallic Liner | \$ 1,260.00 |
| HD-22 | 22' | Heavy Duty Hose Guide With Metallic Liner | \$ 1,195.00 |
| HD-24 | 24' | Heavy Duty Hose Guide With Metallic Liner | \$ 1,286.00 |
| HD-25 | 25' | Heavy Duty Hose Guide With Metallic Liner | \$ 1,496.00 |



| | | | |
|---------------|------------|----------------------------------------------------------|--------------------|
| HDS-7 | 7' | Heavy Duty Hose Guide With Heavy Duty Steel Spring Liner | \$ 885.00 |
| HDS-10 | 10' | Heavy Duty Hose Guide With Heavy Duty Steel Spring Liner | \$ 1,110.00 |
| HDS-15 | 15' | Heavy Duty Hose Guide With Heavy Duty Steel Spring Liner | \$ 1,365.00 |
| HDS-18 | 18' | Heavy Duty Hose Guide With Heavy Duty Steel Spring Liner | \$ 1,512.00 |
| HDS-20 | 20' | Heavy Duty Hose Guide With Heavy Duty Steel Spring Liner | \$ 1,628.00 |
| HDS-22 | 22' | Heavy Duty Hose Guide With Heavy Duty Steel Spring Liner | \$ 1,764.00 |
| HDS-24 | 24' | Heavy Duty Hose Guide With Heavy Duty Steel Spring Liner | \$ 1,827.00 |
| HDS-25 | 25' | Heavy Duty Hose Guide With Heavy Duty Steel Spring Liner | \$ 1,890.00 |



| | | | |
|----------------|------------|----------------------------------------------------|--------------------|
| LW-15BF | 15' | Below Freezing Hose Guide With Flex-Metallic Liner | \$ 1,169.00 |
| LW-18BF | 18' | Below Freezing Hose Guide With Flex-Metallic Liner | \$ 1,273.00 |
| LW-20BF | 20' | Below Freezing Hose Guide With Flex-Metallic Liner | \$ 1,350.00 |
| LW-22BF | 22' | Below Freezing Hose Guide With Flex-Metallic Liner | \$ 1,433.00 |
| LW-24BF | 24' | Below Freezing Hose Guide With Flex-Metallic Liner | \$ 1,470.00 |
| LW-25BF | 25' | Below Freezing Hose Guide With Flex-Metallic Liner | \$ 1,502.00 |



SPECIAL HD

CAM-LOCK ENDS With 2" heavy duty iron Cam-Lock fitting male end **\$ 130.00**

add **"MI"** to part number or add female end add **"FI"** to part number

Example: **7'** light rod guide hose with male 2": heavy duty iron Cam Lock fittings part No. LW-7MI \$660.00 + \$130.00 = \$790.00

STEEL ENDS*

ANY ABOVE HOSE CAN BE ORDERED WITH STEEL ENDS BY ADDING **"SE"** TO PART NUMBER AND ADDING **\$160.00**, COMES WITH FEMALE END FOR HOSE GUIDE BELL AND STEEL MALE END FOR RODDING MACHINE

| | | |
|------------|----------------------------------------|------------------|
| HGB | HOSE GUIDE BELL | \$ 193.00 |
| SPB | SINGLE PRONG BRACE WITH CHAIN AND ROPE | \$ 219.00 |
| SPR | SINGLE PRONG BRACE WITH RING AND ROPE | \$ 226.00 |
| HGS | HOSE GUIDE STAND | \$ 400.00 |



| | | |
|---------------|--------------------------------------------------------|------------------|
| SME-1M | STEEL END WITH STEEL 2" MALE CAMLOCK STEEL | \$ 275.00 |
| SME-1F | END WITH STEEL 2" FEMALE CAMLOCK | \$ 275.00 |
| SFE | STEEL FEMALE FOR BELL FOR HOSE GUIDE BELL | \$ 221.00 |
| SME | STEEL MALE FOR BELL FOR HOSE GUIDE BELL | \$ 221.00 |
| SCL-1 | STEEL FEMALE X FEMALE STRAIGHT COUPLER | \$ 82.00 |
| SCL-2 | SET OF CLAMPS FOR ATTACHED STEEL ENDS TO HOSE | \$ 38.00 |
| SCL-3 | ALUMINUM BELL END FOR GUIDE HOSE | \$ 149.00 |
| SCL-4 | ALUMINUM MALE END FOR GUIDE HOSE | \$ 149.00 |
| SCL-5 | INSERT GUIDE | \$ 25.00 |
| SCL-6 | LIGHTWEIGHT FLEX-METALLIC LINER AND LW HOSE (PER FOOT) | \$ 41.00 |
| SCL-7 | HEAVY DUTY HOSE WITH FLEX-METALLIC LINER (PER FOOT) | \$ 53.00 |
| SCL-8 | FLEX-METALLIC LINER ONLY (PER FOOT) | \$ 20.00 |

CONTINUOUS ROD TIER 2 PRODUCT

CONTINUOUS ROD PRICE PER FOOT

| | | |
|---------|----------------------|---------|
| STC-1-2 | 0.375 Continuous Rod | \$ 1.66 |
| STC-1-3 | 0.393 Continuous Rod | \$ 1.68 |
| STC-1-5 | 0.461 Continuous Rod | \$ 1.92 |



CONTINUOUS ROD TRANSFER RACK

CRTR-1 6 SPOKE HEAVY DUTY TRANSFER RACK. 6 SPOKE AND GUIDE ARM \$ 1,995.00

| | | |
|-------|-----------------------|-----------|
| SRK-1 | 0.375 Rod Bending Kit | \$ 320.00 |
| SRK-2 | 0.393 Rod Bending Kit | \$ 320.00 |
| SRK-4 | 0.461 Rod Bending Kit | \$ 320.00 |



ADAPTER COUPLINGS

ADAPTER COUPLINGS FOR CONNECTING CONTINUOUS ROD TO TOOLS

| | | |
|--------|------------------------------------------------------|----------|
| AC-1-1 | 0.375 Set screw type, to 3/8" COARSE RH THREAD | \$ 31.00 |
| AC-1-2 | 0.393 Set screw type, to 3/8" COARSE RH THREAD | \$ 31.00 |
| AC-1-4 | 0.461 Set screw type, to 3/8" COARSE RH THREAD | \$ 31.00 |
| AC-2-1 | 0.375 Fine LH thread Hook, to 5/16" COARSE RH THREAD | \$ 31.00 |
| AC-2-2 | 0.393 Fine LH thread Hook, to 5/16" COARSE RH THREAD | \$ 31.00 |
| AC-2-4 | 0.461 Fine LH thread Hook, to 5/16" COARSE RH THREAD | \$ 31.00 |
| AC-3-1 | 0.375 Set screw type, to 5/16" COARSE RH THREAD | \$ 31.00 |
| AC-3-2 | 0.393 Set screw type, to 5/16" COARSE RH THREAD | \$ 31.00 |
| AC-3-4 | 0.461 Set screw type, to 5/16" COARSE RH THREAD | \$ 31.00 |
| AC-4-1 | 0.375 Fine LH thread hook, to 3/8" COARSE RH THREAD | \$ 31.00 |
| AC-4-2 | 0.393 Fine LH thread hook, to 3/8" COARSE RH THREAD | \$ 31.00 |
| AC-4-4 | 0.461 Fine LH thread hook, to 3/8" COARSE RH THREAD | \$ 31.00 |
| AC-5-1 | 5/16" LH Fine thread Hook to 3/8" COARSE RH THREAD | \$ 31.00 |



| | | |
|---------|------------------------------------|---------|
| CN-1-1 | 5/16" Coarse Thread Right Hand Nut | \$ 4.00 |
| CN-1-2 | 5/16" Fine thread Left Hand Nut | \$ 4.00 |
| CN-1-3 | 3/8" Coarse Thread Left Hand Nut | \$ 4.00 |
| CN-1-4 | 3/8" Fine Thread Left Hand Nut | \$ 4.00 |
| CN-1-5 | 0.375 Coarse Thread Right Hand Nut | \$ 4.00 |
| CN-1-6 | 0.375 Fine thread Left Hand Nut | \$ 4.00 |
| CN-1-7 | 0.393 Coarse Thread Right Hand Nut | \$ 4.00 |
| CN-1-8 | 0.393 Fine Thread Left Hand Nut | \$ 4.00 |
| CN-1-11 | 0.461 Coarse Thread Right Hand Nut | \$ 4.00 |
| CN-1-12 | 0.461 Fine Thread Left Hand Nut | \$ 4.00 |

Fine Thread

Coarse Thread



COUPLINGS FOR SECTIONAL AND CONTINUOUS ROD

| | | |
|--------|------------------------------------|----------|
| CC-1-1 | 5/16" LH fine x RH Coarse Coupling | \$ 13.00 |
| CC-1-2 | 3/8" LH fine x RH Coarse Coupling | \$ 16.00 |

City Coupling



CC-1-1, 2

COUPLINGS FOR SQUARE STOCK CORKSCREW

| | | |
|---------|--------------------------------------------|----------|
| CS-1-1 | 5/16" To Be Used With Adapter Rods | \$ 14.00 |
| CS-1-2 | 3/8" To Be Used With Adapter Rods | \$ 18.00 |
| CS-1-3 | 0.375 To Be used with Set Screw Connection | \$ 28.00 |
| CS-1-4 | 0.393 To Be used with Set Screw Connection | \$ 28.00 |
| CS-1-6 | 0.461 To Be used with Set Screw Connection | \$ 28.00 |
| CS-1-7 | 0.375 To Be used with Hook Type Connection | \$ 28.00 |
| CS-1-8 | 0.393 To Be used with Hook Type Connection | \$ 28.00 |
| CS-1-10 | 0.461 To Be used with Hook Type Connection | \$ 28.00 |



CS-1-1,-2



CS-1-3....

COUPLINGS FOR STANDARD ROOT SAW

| | | |
|--------|--------------------------------------------|----------|
| CR1-1 | 5/16" To Be Used With Adapter Rods | \$ 19.00 |
| CR1-2 | 3/8" To Be Used With Adapter Rods | \$ 21.00 |
| CR1-3 | 0.375 To Be used with Set Screw Connection | \$ 28.00 |
| CR1-4 | 0.393 To Be used with Set Screw Connection | \$ 28.00 |
| CR1-6 | 0.461 To Be used with Set Screw Connection | \$ 28.00 |
| CR1-7 | 0.375 To Be used with Hook Type Connection | \$ 28.00 |
| CR1-8 | 0.393 To Be used with Hook Type Connection | \$ 28.00 |
| CR1-10 | 0.461 To Be used with Hook Type Connection | \$ 28.00 |



CR1-1-1,-2



CR1-3....

QUICK CONNECT COUPLINGS

| | | |
|-------|----------------------------------------------------|----------|
| QCP-1 | 5/16" Quick Connect Female Coupling for 5/16" Rods | \$ 14.00 |
| QCM-1 | 5/16" Quick Connect Male Coupling for 5/16" Rods | \$ 14.00 |
| QCF-2 | 1/4" Quick Connect Female Coupling for 1/4" Rods | \$ 14.00 |
| QCM-2 | 1/4" Quick Connect Male Coupling for 1/4" Rods | \$ 14.00 |



COUPLINGS FOR HD ROOT SAWS

| | | | |
|---------|-------|--------------------------------------|----------|
| CRHD-1 | 5/16" | To Be Used With Adapter Rods | \$ 20.00 |
| CRHD-2 | 3/8" | To Be Used With Adapter Rods | \$ 22.00 |
| CRHD-3 | 0.375 | To Be used with Set Screw Connection | \$ 30.00 |
| CRHD-4 | 0.393 | To Be used with Set Screw Connection | \$ 30.00 |
| CRHD-6 | 0.461 | To Be used with Set Screw Connection | \$ 30.00 |
| CRHD-7 | 0.375 | To Be used with Hook Type Connection | \$ 30.00 |
| CRHD-8 | 0.393 | To Be used with Hook Type Connection | \$ 30.00 |
| CRHD-9 | 0.415 | To Be used with Hook Type Connection | \$ 30.00 |
| CRHD-10 | 0.461 | To Be used with Hook Type Connection | \$ 30.00 |



COUPLINGS FOR AUGERS 2", 3" & 4"

| | | | |
|---------|-------|--------------------------------------|----------|
| CA-1-1 | 5/16" | To Be Used With Adapter Rods | \$ 20.00 |
| CA-1-2 | 3/8" | To Be Used With Adapter Rods | \$ 22.00 |
| CA-1-3 | 0.375 | To Be used with Set Screw Connection | \$ 30.00 |
| CA-1-4 | 0.393 | To Be used with Set Screw Connection | \$ 30.00 |
| CA-1-6 | 0.461 | To Be used with Set Screw Connection | \$ 30.00 |
| CA-1-7 | 0.375 | To Be used with Hook Type Connection | \$ 30.00 |
| CA-1-8 | 0.393 | To Be used with Hook Type Connection | \$ 30.00 |
| CA-1-9 | 0.415 | To Be used with Hook Type Connection | \$ 30.00 |
| CA-1-10 | 0.461 | To Be used with Hook Type Connection | \$ 30.00 |



COUPLINGS FOR AUGERS 6", 10" AND UP

| | | | |
|---------|-------|--------------------------------------|----------|
| CA-2-1 | 5/16" | To Be Used With Adapter Rods | \$ 20.00 |
| CA-2-2 | 3/8" | To Be Used With Adapter Rods | \$ 22.00 |
| CA-2-3 | 0.375 | To Be used with Set Screw Connection | \$ 30.00 |
| CA-2-4 | 0.393 | To Be used with Set Screw Connection | \$ 30.00 |
| CA-2-6 | 0.461 | To Be used with Set Screw Connection | \$ 30.00 |
| CA-2-7 | 0.375 | To Be used with Hook Type Connection | \$ 30.00 |
| CA-2-8 | 0.393 | To Be used with Hook Type Connection | \$ 30.00 |
| CA-2-9 | 0.415 | To Be used with Hook Type Connection | \$ 30.00 |
| CA-2-10 | 0.461 | To Be used with Hook Type Connection | \$ 30.00 |



NO. 5 PLUMBER RODS

P5-13 1/4" X 6' No. 5 PLUMBERS RODS. HEX COUPLING AND 1/4" X 6' LONG. SILVER CHROME COATED ROD \$ 19.00



| | | |
|----------------|-------------------------------------------------------------------------------------------|-----------|
| P5-1 | Frame only made to accommodate 17-25 Rods | \$ 117.00 |
| P5-2 | 2" Round wire "COILED" Corkscrew Made From 1/4" Material with Hex Coupling Rod | \$ 79.00 |
| P5-2M | 2" OD Round Wire "COILED" Corkscrew Made From 1/4" Material with Welded 5/16" Pigtail | \$ 102.00 |
| P5-3 | 3" Double Rounded Wire "COILED" Corkscrew Made From 1/4" Material with Hex Coupling Rod | \$ 111.00 |
| P5-3M | 3" Double Round Wire "COILED" Corkscrew Made From 1/4" Material with Welded 5/16" Pigtail | \$ 139.00 |
| P5-4 | 4" Round Wire "COILED" Corkscrew For Use with 1/4" Hex Coupling Rod | \$ 86.00 |
| P5-4M | 4" OD Round Wire "COILED" Corkscrew Made From 1/4" Material with Welded 5/16" Pigtail | \$ 119.00 |
| P5-5-2 | 2" Root Cutter "COILED" Spade Blade Made from 1/4" Material with Hex Coupling Rod | \$ 143.00 |
| P5-5-2M | 2" Root Cutter "COILED" Spade Blade Made from 1/4" Material with Welded 5/16" Pigtail | \$ 120.00 |
| P5-5-3 | 3" Root Cutter "COILED" Spade Blade Made from 1/4" Material with Hex Coupling Rod | \$ 149.00 |
| P5-5-3M | 3" Root Cutter "COILED" Spade Blade Made from 1/4" Material with Welded 5/16" Pigtail | \$ 149.00 |
| P5-5-4 | 4" Root Cutter "COILED" Spade Blade Made from 1/4" Material with Hex Coupling Rod | \$ 139.00 |
| P5-5-4M | 4" Root Cutter "COILED" Spade Blade Made from 1/4" Material with Welded 5/16" Pigtail | \$ 158.00 |
| P5-6 | 2" Spear Head "COILED" For use with 1/4" Hex Coupling Rod | \$ 149.00 |
| P5-6M | 2" SPEAR HEAD "COILED" FOR USE WITH 5/16" Welded City Coupling Rod | \$ 119.00 |
| P5-7 | Pick-up Tool with "COILED" Pigtail for use with 1/4" Hex Coupling Rod | \$ 77.00 |
| P5-7M | Pick-up Tool with "COILED" Pigtail for use with 5/16" Welded City Coupling Rod | \$ 103.00 |
| P5-8 | Assembly Tool for No. 5 Rods | \$ 59.00 |
| P5-9 | Electric Drill Adapter | \$ 78.00 |
| P5-10 | Pull Out Turning Handle | \$ 80.00 |

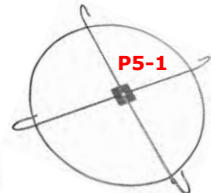

P5-SET COMPLETE NO. 5 SET IS COMPRISED OF: \$ 1,183.00

| | | |
|---------------------------------|------------------------------|-------------------------------------|
| 17ea. P5-15-13 (1/4" X 6' RODS) | 1ea. P5-4 (4" CORKSCREW) | 1ea. P5-8 (ASSEMBLY TOOL) |
| 1ea. P5-1 (ROD FRAME) | 1ea. P5-5-3 (3" ROOT CUTTER) | 1ea. P5-9 (ELECTRICK DRILL ADAPTER) |
| 1ea. P5-2 (2" CORKSCREW) | 1ea. P5-6 (2" SPEAR HEAD) | 1ea. P5-10 (TURNING HANDLE) |
| 1ea. P5-3 (3" DOUBLE ROUNDWIRE) | 1ea. P5-7 (PICK-UP TOOL) | |

ADD "B" TO ANY TOOL ABOVE FOR A PIG TAIL WITH A "B" NUT, AND ADD \$3.00 (LIST)

ADD "M" TO ANY ABOVE CLEANING TOOL FOR A 5/16" PIGTAIL FOR AN ADDITIONAL \$15.00 (LIST)

"B" PLUMBERS RODS AND TOOLS

PB-1 **1/4" X 6'** "B" ROD COMPLETE (ROUND COUPLING) \$ 20.00
 High strength Electro-statically charged flexible **Black** Sewer Rod



PB-2 PICK UP TOOL \$ 68.00



PB-3 4" CORKSCREW \$ 62.00
PB-4 2" CORKSCREW \$ 62.00

PB-5-3 3" ROOT CUTTER \$ 116.00
PB-5-4 4" ROOT CUTTER \$ 119.00
PB-5-2 2" ROOT CUTTER \$ 114.00



PB-6 2" SPEAR HEAD \$ 73.00
PB-7 ASSEMBLY TOOL \$ 46.00
PB-8 TURNING HANDLE \$ 68.00



PB-9 4" TAPERED CORKSCREW (NOT IN SET BELOW) \$ 110.00
PB-10 2" TAPERED CORKSCREW (NOT IN SET BELOW) \$ 110.00

PB-SET COMPLETE "B" PLUMBERS SET \$ 1,049.00



SET INCLUDES 17 RODS AND 1 EACH OF ALL TOOLS ABOVE EXCEPT PB-9, PB-10 AND PB-5-2

SPECIAL COILED SPRING ITEMS

| | | |
|---------------|-----------------------------------------------------------------|-----------|
| SSU-1 | 1" O.D. OF 1/4" WIRE X 12" LONG WITH RH X LH 5/16" NUTS | \$ 99.00 |
| SSU-2 | 1 1/4" O.D. OF 5/16" WIRE X 12" LONG WITH RH X LH 5/16" NUTS | \$ 132.00 |
| SSCR-3 | 1" X 3' COILED 1/4" ROD WITH RH X LH 5/16" NUTS | \$ 160.00 |
| SCR-25 | 1" X 25' COILED 1/4" ROD WITH 5/16" WELDED PIGS TAILS EACH SIDE | \$ 578.00 |
| SCR-3A | 1" X 3' COILED ROD WITH AUGER COUPLING X 5/16" Pig Tail | \$ 201.00 |
| PF-7 | 1" X 25' COILED ROD 1/4" PLUMBERTOOL MALE X FEMALE | \$ 578.00 |
| PF-20M | 1" X 3' LONG COILED ROD WITH 3" ROOT SAW X 5/16" | \$ 277.00 |
| PF-21M | 1" X 3' LONG COILED ROD WITH 4" ROOT SAW X 5/16" | \$ 310.00 |
| PF-22M | 1" X 3' LONG COILED ROD WITH 6" ROOT SAW X 5/16" | \$ 337.00 |
| PF-8 | 1" FEMALE COILED ROD COUPLER | \$ 26.00 |
| PF-9 | 1" MALE COILED ROD COUPLER | \$ 26.00 |



VALVES

| | | | |
|--------------------|--------|---------------------------------------|-----------|
| BHK-1-2 | 1" | 2-WAY BLOCK STYLE BALL VALVE 5000 PSI | \$ 165.00 |
| BHK-3/4-2 | 3/4" | 2-WAY BLOCK STYLE BALL VALVE 5000 PSI | \$ 126.00 |
| BHK-1-1/4-2 | 1 1/4" | 2-WAY BLOCK STYLE BALL VALVE 5000 PSI | \$ 192.00 |
| BHK-1-3 | 1" | 3-WAY BLOCK STYLE BALL VALVE 5000 PSI | \$ 247.00 |
| BHK-3/4-3 | 3/4" | 3-WAY BLOCK STYLE BALL VALVE 5000 PSI | \$ 247.00 |

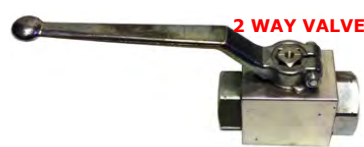

HOSE REEL SWIVELS (TIER 2 PRODUCT)

| | | | |
|----------------|--------|------------|-----------|
| SSE-34E | 3/4" | 90° SWIVEL | \$ 374.00 |
| SSE-1E | 1" | 90° SWIVEL | \$ 374.00 |
| SSE-12E | 1 1/4" | 90° SWIVEL | \$ 374.00 |



SSE-34-1-RKIT INCLUDES SEALS, BEARINGS AND BACK-UP RING for 3/4" or 1" Swivel \$ 95.00
SSE-125-RKIT INCLUDES SEALS, BEARINGS AND BACK-UP RING for 1 1/4" Swivel \$ 95.00

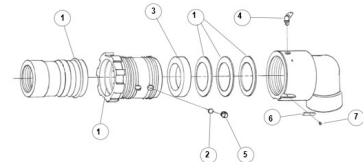

- 1 - Seals
- 2 - Bearings
- 3 - Back-up Ring
- 4 - Cork Grosse Fitting
- 5 - Bearing Tap Screw
- 6 - Keyway
- 7 - Keyway Retaining Screw

MANHOLE HOOKS

POOK DOUBLE SIDED PICK AND MANHOLE HOOK \$ 254.00

This is the famous Pook that is well known in cities across America for those who want the toughest manhole hook. Hook and Pick combined to make a "Pook". One side of the 2 sided head is a sharp pick to chip away at asphalt or any other hard surface. The other side has a hook that has the perfect angle to fit in the hole and lift up any manhole lid. This complete unit is made from 4130 high carbon steel that is heat treated to exacting numbers. The handle is 3/4" thick!! Nice triangle flat against your palm. Powder coated safety orange



- MSRH-1** MANHOLE HOOK, 9/16" HARDENED STEEL **TRIANGLE HANDLE, 39" LONG, 90°** \$ 147.00
- MSRH-2** MANHOLE HOOK, 9/16" HARDENED STEEL **TRIANGLE HANDLE, 27" LONG, FLAT** \$ 147.00
- MSRH-3** MANHOLE HOOK, 9/16" HARDENED STEEL **TRIANGLE HANDLE, 39" LONG, FLAT** \$ 147.00
- MSRH-4** MANHOLE HOOK, 9/16" HARDENED STEEL **TRIANGLE HANDLE, 27" LONG, 90°** \$ 147.00

MSRT-1 "T" HANDLE MANHOLE HOOK, 39" LONG WITH RADIUS (NEW DESIGN) \$ 158.00

Triangle Handle

"T" Handle

MVBL-1

SPECIALTY TOOLS NOT OTHERWISE ACCOUNTED FOR

FIBERGLASS POLE SUPPORT BRACKET

M-730 POLE SUPPORT BRACKET WITH WINGED HINGE \$ 213.00
 This handy tool will keep your pole supported above manhole rim. Hinged in middle so it folds up and is easy to store. Interior rubber gasket keeps pole in place.

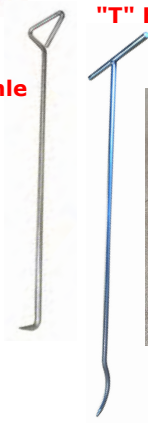

MVBL-1 The Valve Box Lifter packs a punch with 100 lb. magnet strength. Equipped with a 30" long T handle, it's easy to place on the cover and lift up. \$ 168.00

INSERT NOZZLE GUIDE

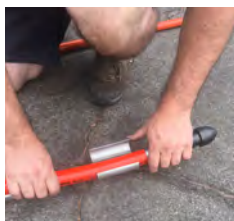

1) Place hose in jaws 2) Close Jaws around hose 3) Lower the guide into place 4) Pull rope and release hose and nozzle

This device connects to our interlocking pole systems. Essentially it will grab and lock the end of your hose where the nozzle is so the operator can put it where he wants. The sewer or duct might be submerged, blind, raised or dropped. Once you have the nozzle securely attached in the jaws you can lower the hose and nozzle into the manhole to the depth you need. At this point you just direct the end of the guide into the sewer line and insert it. At this point you can open the water flow so that your nozzle will take off in the line once you open the guide jaws. With a slight "tug" on the rope you will open the jaws and release the hose and nozzle. YOU'RE DONE. PULL UP GUIDE TO THE STREET.

ING-SS INSERT GUIDE ONLY. INCLUDES 25' NYLON ROPE. CONNECTS TO OUR QUICK CONNECT POLE SYSTEM. \$ 1,080.00

ING-SS-24K INSERT NOZZLE GUIDE KIT INCLUDES 25' FIBERGLASS POLES AND 25' NYLON ROPE \$ 1,329.00

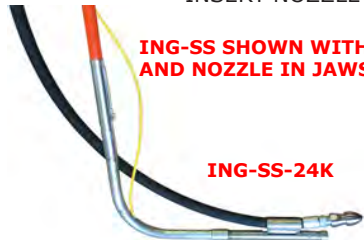

ING-SS SHOWN WITH HOSE AND NOZZLE IN JAWS

ING-SS-24K



PULL THE ROPE AND JAWS RELEASE



ING-SS

PLASTIC MANHOLE PROTECTION RING

MPR-75 19" TO 22" MANHOLE PROTECTION RING Your Net \$ 273.00

MPR-100 24" TO 27" MANHOLE PROTECTION RING Your Net \$ 273.00

MPR-125 30" TO 34" MANHOLE PROTECTION RING Your Net \$ 305.00



ANTI-SPLASH MANHOLE SAFETY COVER FOR VIDEO INSPECTION AND SEWER HOSE CLEANING

CONCERNED ABOUT SEWER MIST? THESE NEW TOP GRILLS HELPS PROTECT OPERATORS HEALTH WITH BUILT IN PLEXIGLASS UNDER COVERS. HELPS PREVENT SEWER MIST FROM BECOMING AIRBORNE TO REDUCE OPERATOR EXPOSURE

This lightweight, All Aluminum manhole safety roller cover not only reduces the possibility of falling into the manhole but **REDUCES** the possibility of **EXPOSURE** by keeping sewer splash and mist in the manhole where it belongs

- CO-2436A PLEXY-PROTECTION GRILL FOR JETTING AND VACUUMING. **FOR 24"-36"** WITH ALUMINUM ROLLER **\$1,755.00**
- CO-2436N PLEXY-PROTECTION GRILL FOR JETTING AND VACUUMING. **FOR 24"-36"** WITH NYLON ROLLER **\$1,720.00**



Aluminum Roller



Nylon Roller



- CO-24A **24"** PLEXY-PROTECTION GRILL FOR JETTING ONLY WITH ALUMINUM ROLLER **\$968.00**
- CO-24N **24"** PLEXY-PROTECTION GRILL FOR JETTING ONLY WITH NYLON ROLLER **\$963.00**



ALUMINUM ROLLER GRILL MANHOLE SAFETY COVER FOR VIDEO INSPECTION AND SEWER HOSE CLEANING

SMR-28A This lightweight all aluminum manhole safety roller grill reduces the possibility to zero of falling into the manhole. Made of aluminum with an aluminum roller and powder coated red it is easy to see. Unique design has hand opening to allow tightening of 4 support screws. Just 15 lbs.

For 20" - 26" Openings

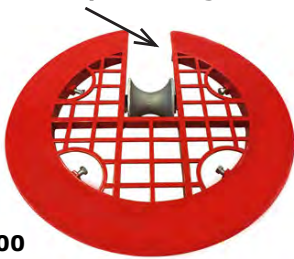

\$ 814.00



\$ 809.00

SMR-28N SAME ALUMINUM ROLLER GRILL MANHOLE SAFETY COVER WITH HIGH DENSITY NYLON ROLLER FOR EVEN LIGHTER WEIGHT. **JUST 11 LBS.**

SMR-36N **36"** Aluminum roller grill manhole safety cover but with High Density Nylon roller for a total weigh of **only 20 lbs.**

SMR-36A Same as above **36"** Aluminum roller Grill with Aluminum roller weighing **only 22 lbs.**

The 36" Aluminum Roller will fit Openings 26" to 34"



\$ 1,210.00



\$ 1,221.00



MAGNETIC BOOM MANHOLE LIFTER

Easily attaches to the end of your boom hose. Either flat flange, male or female *BAND-LOCK* type. **Weights 25lbs with 1100lbs. capacity.**

- **Attach to Boom**
- **Lower onto Manhole lid**
- **Lift off and Detach.**

MBL-61 LIFTER WITH **6"** FLAT FLANGE 'VACTOR - VAC-CON' **\$ 670.00**
MBL-81 LIFTER WITH **8"** FLAT FLANGE 'VACTOR - VAC-CON' **\$ 680.00**

ALSO AVAILABLE WITH "FEMALE CAMEL/VAC-ALL AND MALE CAMEL/VAC-ALL"

MHL-6 **6"** FLAT FLANGE LIFTER 'VACTOR - VAC-CON' W/O MAGNET **\$ 324.00**
MHL-8 **8"** FLAT FLANGE LIFTER 'VACTOR - VAC-CON' W/O MAGNET **\$ 324.00**



NEW !!!

MAGNETIC BOOM MANHOLE LIFTER

AMHL-HH ALUMINUM MANHOLE LIFTER With **1100 lbs. Capacity Magnetic Lifter Included**





Southland Tool Mfg. Inc.
1430 N. Hundley St.
Anaheim, CA 92806
Tel: 714.632.8198 • Fax: 714.632.8228
www.southlandtool.com • sales@southlandtool.com